



**PLEASE CHECK FOR CHANGE INFORMATION
AT THE REAR OF THIS MANUAL.**

**7834
STORAGE
OSCILLOSCOPE
WITH OPTIONS
OPERATORS**

INSTRUCTION MANUAL

**Tektronix, Inc.
P.O. Box 500
Beaverton, Oregon 97077**

Serial Number _____

070-1987-00
Product Group 42

First Printing OCT 1976
Revised JUL 1983

Copyright © 1976 Tektronix, Inc. All rights reserved.
Contents of this publication may not be reproduced in any
form without the written permission of Tektronix, Inc.

Products of Tektronix, Inc. and its subsidiaries are covered
by U.S. and foreign patents and/or pending patents.

TEKTRONIX, TEK, SCOPE-MOBILE, and  are
registered trademarks of Tektronix, Inc. TELEQUIPMENT
is a registered trademark of Tektronix U.K. Limited.

Printed in U.S.A. Specification and price change privileges
are reserved.

INSTRUMENT SERIAL NUMBERS

Each instrument has a serial number on a panel insert, tag,
or stamped on the chassis. The first number or letter
designates the country of manufacture. The last five digits
of the serial number are assigned sequentially and are
unique to each instrument. Those manufactured in the
United States have six unique digits. The country of
manufacture is identified as follows:

B000000	Tektronix, Inc., Beaverton, Oregon, USA
100000	Tektronix Guernsey, Ltd., Channel Islands
200000	Tektronix United Kingdom, Ltd., London
300000	Sony/Tektronix, Japan
700000	Tektronix Holland, NV, Heerenveen, The Netherlands

TABLE OF CONTENTS

	PAGE		PAGE
LIST OF ILLUSTRATIONS	ii	DETAILED OPERATING INFORMATION	2-11
LIST OF TABLES	iii	Graticule	2-11
SAFETY SUMMARY	iv	Light Filter	2-11
SECTION 1 GENERAL INFORMATION		Control Illumination	2-11
INTRODUCTION	1-1	Intensity Controls	2-11
INSTALLATION	1-1	Display Focus	2-12
Initial Inspection	1-1	Astigmatism-Focus Adjustments	2-12
Operating-Power Information	1-1	Beamfinder	2-12
Operating Voltage	1-2	Trace Alignment	2-12
Operating Temperature	1-2	Readout Display	2-12
Operating Position	1-3	Reduced Scan Mode	2-14
PACKAGING FOR SHIPMENT	1-3	Storage Display	2-14
SPECIFICATION	1-4	Care of Storage Screen	2-16
SYSTEM ELECTRICAL SPECIFICATION	1-15	Vertical and Horizontal Mode Combinations	2-16
STANDARD ACCESSORIES	1-18	Vertical Trace Separation	2-19
RECOMMENDED ACCESSORIES	1-19	Trigger Source	2-19
SECTION 2 OPERATING INSTRUCTIONS		Calibrator Output	2-19
PRELIMINARY OPERATION	2-1	Signal Outputs	2-19
PLUG-IN UNITS	2-1	Display Photography	2-20
Installation of Plug-In Units	2-1	Intensity Modulation	2-20
CONTROLS AND CONNECTORS	2-1	Remote Input Signals	2-21
Front-Panel Color Coding	2-1	APPLICATIONS	2-21
FUNCTIONAL CHECK	2-1	Vertical Amplifier Plug-In Units	2-21
Test Equipment Required	2-1	Time-Base Plug-In Units	2-22
Preliminary Set Up	2-6	Sampling Displays	2-22
Display Focus	2-6	Special Purpose Plug-In Units	2-22
Trace Alignment	2-7	X-Y Operation	2-23
Graticule Illumination	2-7	Raster Displays	2-23
Control Illumination	2-7	SECTION 3 INSTRUMENT OPTIONS	
Vertical Deflection System	2-7	OPTION 1	3-1
Horizontal Deflection System	2-7	OPTION 2	3-1
Triggering	2-8	OPTION 3	3-1
Readout	2-8		
Beamfinder	2-9		
Calibrator	2-9		
Z-Axis Input	2-9		
Storage Operation	2-9		

LIST OF ILLUSTRATIONS

FIGURE NO.		PAGE
Frontis- piece	7834 Features.	vi
1-1	7834 dimensional drawing.	1-14
2-1	Front-panel controls, connectors and indicators.	2-2
2-2	Rear-panel controls and connectors.	2-4
2-3	Definition of graticule measurement lines	2-11
2-4	Location of readout on the crt identifying the originating plug-in and channel	2-13
2-5	Location of readout on the crt when REDUCED SCAN is selected	2-13

LIST OF TABLES

TABLE NO.		PAGE
1-1	Power-Cord Conductor Identification	1-2
1-2	Power-Cord Plug Configuration	1-2
1-3	Shipping Carton Test Strength	1-3
1-4	Electrical Characteristics	1-4
1-5	Environmental	1-13
1-6	Physical	1-14
1-7	7834 Oscilloscope Vertical System Specification	1-16
1-8	7834 Oscilloscope System Horizontal Specification	1-17
1-9	Special Purpose Plug-In Units.	1-17
2-1	Display Combinations	2-16
3-1	Option Information Locator	3-2



SAFETY INFORMATION

The following general safety information applies to all operators and service personnel. Specific warnings will be found throughout the manual where they apply and should be followed in each instance.

WARNING statements identify conditions or practices which could result in personal injury or loss of life.

CAUTION statements identify conditions or practices which could result in damage to the equipment or other property.

The word **DANGER** on the equipment identifies areas of immediate hazard which could result in personal injury or loss of life.

The following safety symbols may appear on the equipment.



CAUTION—Refer to manual



DANGER—High voltage



Protective ground (earth) terminal

Other warning symbols where they apply.

WARNING

AC Power Source and Connection

This instrument operates from a single-phase power source. It has a three-wire power cord and a two-pole, three-terminal grounding-type connector. The voltage to ground (earth) from either pole of the power source must not exceed the maximum rated operating voltage, 250 volts.

Before making connection to the power source, determine that the instrument is adjusted to match the voltage of the power source, and has a suitable two-pole, three-terminal grounding-type connector. Refer any changes to qualified service personnel.

Grounding the Instrument

This instrument is safety class I equipment (IEC designation). All accessible conductive parts are directly connected through the grounding conductor of the power cord to the grounding contact of the power connector.

The power-input plug must be inserted only into a mating receptacle with a grounding contact. Do not defeat the grounding connection. Any interruption of the grounding connection can create an electric-shock hazard. Refer to qualified service personnel for verification of adequate protective grounding system to which this instrument is to be connected.

For electric-shock protection, the grounding connection must be made before making connection to the instrument's input or output terminals.

Do Not Remove Instrument Covers

To avoid electric-shock hazard, operating personnel must not remove the protective instrument covers. Component replacement and internal adjustments must be made by qualified service personnel only.

Do Not Remove CRT Implosion Shield

Do not remove the clear plastic implosion shield covering the crt faceplate. This crt implosion shield provides protection to the operator from crt implosion.



Use the Proper Fuse

Refer fuse replacement to qualified personnel only. To avoid fire hazard, use only the fuse specified in the parts list for your instrument and which is identical in the following respects:

- A. Type: Slow blow, fast blow, etc.*
- B. Voltage rating: 250 V, etc.*
- C. Current rating.*

Operating-Power Considerations

To prevent damage to the instrument always check the LINE VOLTAGE SELECTOR switch, located on the rear of the instrument, before connecting the instrument to the supply circuit.

Exercise Care With Intensity Level

Crt phosphor damage can occur under adverse conditions. Avoid any condition where an extremely bright, sharply-focused dot exists on the crt. Also, remember that the light filter reduces the apparent light output from the crt.

Prevent Instrument Damage

Plug-in units should not be installed or removed without first turning the instrument power off, to prevent instrument damage.

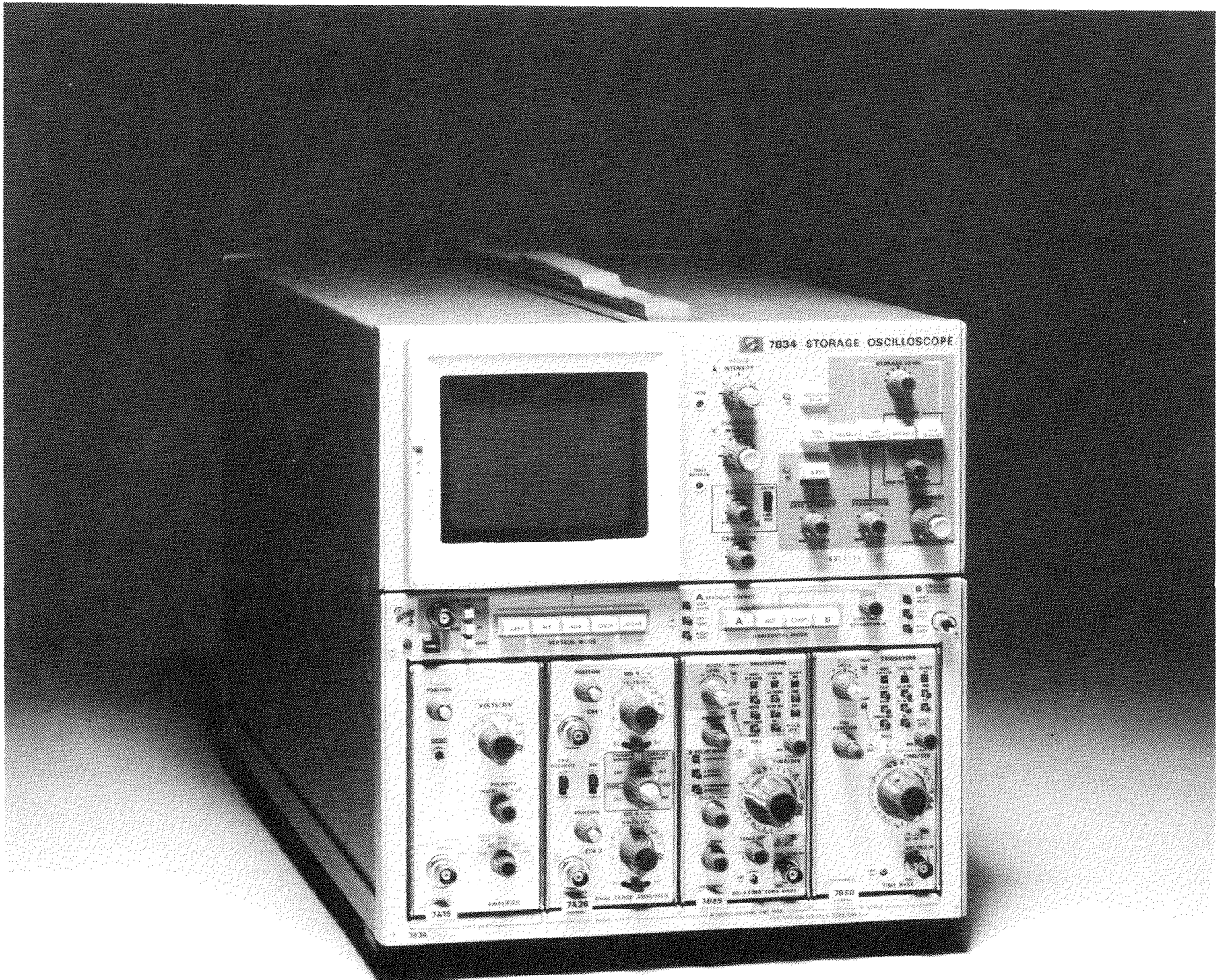

1987-8

7834 FEATURES

The Tektronix 7834 Storage Oscilloscope is a solid-state instrument designed for fast-writing speed storage applications. Three display modes are available at the front panel—Nonstore, Store, and Save; as well as four storage modes—Bistable, Variable Persistence, Fast Bistable, and Fast Variable Persistence. In addition, the REDUCED SCAN feature increases the stored-writing speed capability.

Power supply voltages are closely regulated to maintain instrument performance when variations in line voltage, line frequency, or plug-in load occur. The light-weight, high-efficiency, power supply operates from 115- or 230-volt nominal supply source (50 to 400 hertz).

The instrument's high vertical bandwidth (400 megahertz), fast-storage-writing speed, and four plug-in compartments which accept 7-series plug-in units, form a highly flexible measurement system.

GENERAL INFORMATION

INTRODUCTION

The Operators Manual is divided into three main sections:

Section 1—General Information; contains instrument description, electrical specifications, environmental characteristics, standard and recommended accessories, installation, and packaging for shipment instructions.

Section 2—Operating Instructions; contains information relative to operating and checking the instrument operation.

Section 3—Instrument Options; contains a description of available options and gives the location of the incorporated information for those options.

The Instruction Manual contains both operating and servicing information for the 7834 Storage Oscilloscope. Sections 1 and 2 of the Instruction Manual contain the same information as Section 1 and 2 of the Operators Manual; the remaining seven sections of the Instruction Manual are as follows:

Section 3—Theory of Operation; contains basic and general circuit analysis that may be useful for servicing or operating the instrument.

Section 4—Maintenance; describes routine and corrective maintenance procedures with detailed instructions for replacing assemblies, subassemblies, and individual components.

Section 5—Performance Check and Adjustment; contains procedures to check the operational performance and electrical characteristics of the instrument. Procedures also include methods for adjustment of the instrument to meet specifications.

Section 6—Instrument Options; contains a description of available options and locations of incorporated information for those options.

Section 7—Replaceable Electrical Parts; contains information necessary to order replaceable parts and assemblies related to the electrical functions of the instrument.

Section 8—Diagrams and Circuit Board Illustrations; includes detailed circuit schematics, locations of assembled boards within the instrument, voltage and waveform information, circuit board component locators, and locations of adjustments to aid in performing the Adjustment procedure.

Section 9—Replaceable Mechanical Parts; includes information necessary to order replaceable mechanical parts and shows exploded drawings which identify assemblies.

INSTALLATION

Initial Inspection

This instrument was inspected both mechanically and electrically before shipment. It should be free of marks or scratches and should meet or exceed all electrical specifications. To confirm this, inspect the instrument for physical damage incurred in transit and test the electrical performance by following the Operating Instructions in Section 2 and Performance Check Procedure in Section 5 of the Instruction Manual. If there is damage or deficiency, contact your local Tektronix Field Office or representative.

Operating-Power Information

This instrument can be operated from either a 115-volt or 230-volt nominal supply source, 48 to 440 hertz.



To prevent damage to the instrument, always check the LINE VOLTAGE SELECTOR switch located on the rear of the instrument before connecting the instrument to the supply circuit.

WARNING

AC POWER SOURCE AND CONNECTION. *This instrument operates from a single-phase power source. It has a three-wire power cord and two-pole, three-terminal grounding-type plug. The voltage to ground (earth) from either pole of the power source must not exceed the maximum rated operating voltage, 250 volts.*

Before making connection to the power source, determine that the instrument is adjusted to match the voltage of the power source, and has a suitable two-pole, three-terminal grounding-type plug. Refer any changes to qualified service personnel.

GROUNDING. *This instrument is safety class I equipment (IEC designation). All accessible conductive parts are directly connected through the grounding conductor of the power cord to the grounding contact of the power plug.*

The power input plug must only be inserted in a mating receptacle with a grounding contact. Do not defeat the grounding connection. Any interruption of the grounding connection can create an electric shock hazard.

For electric shock protection, the grounding connection must be made before making connection to the instrument's input or output terminals.

TABLE 1-1
Power-Cord Conductor Identification

Conductor	Color	Alternate Color
Ungrounded (Line)	Brown	Black
Grounded (Neutral)	Blue	White
Grounded (Earthing)	Green-Yellow	Green-Yellow

The power-cord plug required depends upon the ac input voltage and the country in which the instrument is to be used. Should you require a power-cord plug other than that supplied with your instrument, refer to the standards listed in Table 1-2.

TABLE 1-2
Power-Cord Plug Configuration

Nominal Supply Voltage	Reference Standards
115 V ac	¹ ANSI C73.11 ² NEMA 5-15-P ³ IEC 83
230 V ac	¹ ANSI C73.20 ³ IEC 83 ⁴ BS 1363 ⁵ CEE 7, sheets IV, VI, and VII ⁶ AS C112 ² NEMA 6-15-P

- ¹ ANSI—American National Standards Institute
- ² NEMA—National Electrical Manufacturer's Association
- ³ IEC—International Electrotechnical Commission
- ⁴ BS—British Standards Institution
- ⁵ CEE—International Commission on Rules for the Approval of Electrical Equipment
- ⁶ AS—Standards Association of Australia

Operating Voltage

The LINE VOLTAGE SELECTOR switch (located on the rear panel) allows selection of 115-volt or 230-volt nominal line voltage operation. To convert from 115-volt to 230-volt operation, change the power cord and plug to match the power-source receptacle, then use a small screwdriver to move the LINE VOLTAGE SELECTOR switch to the desired range.

Operating Temperature

The 7834 can be operated where the ambient air temperature is between 0° and +50° C. This instrument can be stored in ambient temperatures from -55° to +75° C. After storage at temperatures outside the operating limits, allow the chassis temperature to reach a safe operating limit before applying power.

The 7834 is cooled by air drawn in through holes in the top, side, and bottom panels and blown out through the fan exhaust. To ensure proper cooling of the instrument, maintain the clearance provided by the feet on the bottom and allow at least 2 inches clearance (more if possible) at the top, sides, and rear of the instrument.

If the internal temperature exceeds a safe operating level, a thermal cutout will disconnect the power to the instrument. Power is automatically restored when the temperature returns to a safe level.

Operating Position

A bail-type stand, mounted on the bottom of the instrument, permits the instrument to be tilted up about 10° for more convenient crt viewing.

REPACKAGING FOR SHIPMENT

If the Tektronix instrument is to be shipped to a Tektronix Service Center for service or repair, attach a tag showing: owner (with address) and the name of an individual at your firm that can be contacted. Include complete instrument serial number and a description of the service required.

Save and re-use the package in which your instrument was shipped. If the original packaging is unfit for use or not available, repackage the instrument as follows:

Surround the instrument with polyethylene sheeting to protect the finish of the instrument. Obtain a carton of corrugated cardboard of the correct carton strength and having inside dimensions of no less than six inches more than the instrument dimensions. Cushion the instrument by tightly packing three inches of dunnage or urethane foam between carton and instrument, on all sides. Seal carton with shipping tape or industrial stapler.

The carton test strength for your instrument is 375 pounds.

SPECIFICATION

The electrical characteristics listed in Table 1-4 apply when the following conditions are met: (1) Adjustment of the instrument must have taken place at an ambient temperature between +20° and +30° C; (2) The instrument must be allowed a 30-minute warm-up period; (3) All specifications are valid at an ambient temperature of 0° to +50° C, unless otherwise stated; (4) All specifications are valid in Full Scan (0.9 cm/div) and Reduced Scan (0.45 cm/div) modes, unless otherwise stated; (5) The instrument must be in an environment that meets the limits described in Table 1-5.

Any applicable conditions not listed above are expressly stated as part of that characteristic.

TABLE 1-4
Electrical Characteristics

Characteristic	Performance Requirement
VERTICAL SYSTEM	
Deflection Factor	Compatible with all 7000-series plug-in units.
Difference Between Vertical Compartments	1% or less.
Low-Frequency Linearity	0.1 div or less compression or expansion of a center-screen 2-div display positioned anywhere vertically within graticule area.
Bandwidth	Varies with plug-in unit selected. See 7834 Oscilloscope Vertical Systems Specification, Table 1-7.
Isolation Between Vertical Compartments	
All Vertical Modes	At least 100:1 from dc to 150 MHz and at least 30:1 from 150 MHz to 400 MHz.
Delay Line	Permits viewing the leading edge of triggering signal. <i>NOTE</i> <i>Not all 7B50-series time-base units can display the leading edge of the trigger signal in the 7834. Refer to Tektronix Products catalog under the specific time-base unit for recommended mainframe use.</i>
Vertical Display Modes	Selected by front-panel VERTICAL MODE switch.
LEFT	Left vertical-unit displayed.
ALT	Display alternates between left and right vertical units.
ADD	Display shows algebraic sum of left and right vertical units.
CHOP	Display chops between left and right vertical units.

TABLE 1-4 (CONT.)
Electrical Characteristics

Characteristic	Performance Requirement
RIGHT	Right vertical-unit displayed.
Chopped Mode Repetition Rate	1 MHz within 20%.
VERT TRACE SEPARATION (B)	Positions "B" trace at least 4 div above and below "A" trace, when 7834 operates in dual-sweep mode.

HORIZONTAL SYSTEM

Deflection Factor	Compatible with all 7000-series plug-in units.
Difference Between Horizontal Compartments	1% or less.
Fastest Calibrated Sweep Rate	1 ns/div.
Horizontal Display Mode	Selected by front-panel HORIZONTAL MODE switch.
A	A horizontal unit displayed.
ALT	Display alternates between A and B horizontal units.
CHOP	Display chops between A and B horizontal units.
B	B horizontal unit displayed.
Chopped Mode Repetition Rate	200 kHz within 20%.
Phase Shift Between Vertical and Horizontal Deflection Systems	2° or less from dc to at least 35 kHz.
With Option 2 (B HORIZ Compartment Only)	2° or less from dc to 1 MHz.
Bandwidth (7834 Horizontal Only with 10 Div Reference)	From dc to at least 1 MHz.
With Option 2 (B HORIZ Compartment Only)	From dc to at least 1 MHz.

TRIGGER SYSTEM

A and B TRIGGER SOURCE	Selected by front-panel switches.
VERT MODE	From vertical unit selected by VERTICAL MODE switch; except that in CHOP mode signals are added algebraically.
LEFT VERT	From left vertical unit only.
RIGHT VERT	From right vertical unit only.

TABLE 1-4 (CONT.)
Electrical Characteristics

Characteristic	Performance Requirement
CALIBRATOR	
Waveshape	Square wave.
Polarity	Positive going with baseline near ground.
Source Impedance	450 Ω .
Output Voltage	(Selected by front-panel CALIBRATOR switch.)
Into 100 k Ω or greater	40 mV, 0.4 V, 4 V.
Into 50 Ω	4 mV, 40 mV, 0.4 V.
Output Current	40 mA available through CALIBRATOR output with optional BNC-to-Current Loop adapter. CALIBRATOR switch must be set to 4 V for calibrated output.
Amplitude Accuracy (P-P Voltage)	Within 1%.
Repetition Rate	1 kHz within 0.25%.
Duty Factor	49.8 to 50.2%.
Rise Time and Fall Time	250 ns or less into 100 pF or less.

SIGNAL OUTPUTS

+SAWTOOTH OUT	
Source	A HORIZ time-base unit or B HORIZ time-base unit.
Polarity	Positive going with baseline at 0 V within 1 V into 1 M Ω .
Output Voltage	
Rate of Rise	
Into 50 Ω	50 mV/unit of time selected by time-base unit time/div switch, within 15%; 100 ns/div max.
Into 1 M Ω	1 V/unit of time selected by time-base unit time/div switch, within 10%; 1 μ s/div max.
Output Resistance	Approximately 950 Ω .

TABLE 1-4 (CONT.)
Electrical Characteristics

Characteristic	Performance Requirement
+ GATE OUT	
Source	A HORIZ time-base unit or B HORIZ time-base unit.
A Gate	Derived from the A HORIZ time-base unit main gate.
B Gate	Derived from the B HORIZ time-base unit main gate.
Dly'd Gate	Derived from the A HORIZ time-base unit delayed gate.
Polarity	
A or B Gate	Positive going with baseline at 0 V within 1.0 V (into 1 M Ω).
A Dly'd Gate	Positive level when A time-base delayed sweep or B sweep is enabled. 0 V within 1.0 V (into 1 M Ω) when sweeps are disabled. Output is always positive when no plug-in is used or plug-in does not provide delayed gate.
Output Voltage	
Into 50 Ω	0.5 V within 10%.
Into 1 M Ω	10 V within 10% (up to 1 μ s/div).
Rise Time Into 50 Ω	20 ns or less.
Output Resistance	Approximately 950 Ω .
VERT SIG OUT	Selected by A TRIGGER SOURCE switch.
Source	Same as A TRIGGER SOURCE.
Output Voltage	
Into 50 Ω	25 mV/div of vertical deflection within 25%.
Into 1 M Ω	0.5 V/div of vertical deflection within 25%.
Bandwidth Into 50 Ω	Varies with vertical plug-in selected; see 7834-Series Oscilloscope Vertical Systems Specification, Table 1-7.
DC Centering	0 V within 1 V into 1 M Ω .
Aberrations	15% or less p-p within 50 ns of step.
Output Resistance	Approximately 950 Ω .

TABLE 1-4 (CONT.)
Electrical Characteristics

Characteristic	Performance Requirement
Z-AXIS SYSTEM	
External Z-Axis Input	
Polarity and Sensitivity	Positive 2 V provides complete blanking from maximum-intensity condition; negative 2 V provides complete unblanking from minimum-intensity condition.
Low-Frequency Response	To dc.
Input Resistance	Approximately 470 Ω.
Input Capacitance	Less than 50 pF.
Open-Circuit Voltage	Approximately 0 V.
Maximum Input Voltage	Within 15 V (dc plus peak ac).
Maximum Repetition Rate	1 MHz.
READOUT DISPLAY	
Readout Modes	
FREE RUN	Selected by front-panel switch.
Storage Mode	
NON-STORE	Continuously displayed.
BISTABLE or VAR PERSIST	Continuously displayed, except turns off during erase cycle.
FAST BISTABLE or FAST VAR PERSIST	Continuously displayed, except turns off at beginning of erase cycle or at initiation of single sweep reset until end of transfer cycle. Also, turns off when displayed time base operates in other than single-sweep mode and MULTI TRACE DLY control is not in detent.
SAVE	Displayed for approximately 1 s after save mode is entered, then turns off.
GATED	
Storage Mode	
NON-STORE	One frame of readout is provided at end of displayed sweep.
BISTABLE	Continuously displayed except turns off from beginning of erase cycle until end of first displayed sweep.

TABLE 1-4 (CONT.)
Electrical Characteristics

Characteristic	Performance Requirement
VAR PERSIST	One frame of readout is provided at the end of displayed sweep. Erase cycle inhibits readout display.
FAST BISTABLE	Continuously displayed except turns off at beginning of erase cycle, or at initiation of single-sweep reset until end of transfer cycle. Also, turns off when displayed time base operates in other than single sweep mode and when MULTI TRACE DLY control is not in detent.
FAST VAR PERSIST	One frame of readout is provided in end of transfer cycle; turns off when displayed time base operates in other than single sweep mode and when MULTI TRACE DLY control is not in detent.
SAVE	
BISTABLE or FAST BISTABLE	Displayed for approximately 1 s after save mode is entered, then turns off.
VAR PERSIST	Allows one frame of readout to be displayed at end of displayed sweep.
FAST VAR PERSIST	Allows one frame of readout to be displayed at end of transfer cycle.
Character Height	
Full Scan	0.35 div to 0.5 div.
Reduced Scan	at least 0.2 div.

DISPLAY

Cathode Ray Tube	
Graticule	
Type	Internal; illuminated with variable edge lighting.
Area	
Full Scan	8 x 10 div; 0.9 cm/div.
Reduced Scan	8 x 10 div; 0.45 cm/div centered on faceplate.
Phosphor	P31.
Stored Vertical and Horizontal Resolution in VAR PERSIST and VAR PERSIST FAST	
Full Scan	10 lines/div.

**TABLE 1-4 (CONT.)
Electrical Characteristics**

Characteristic	Performance Requirement
High Voltage Overall Accelerating Voltage	Approximately 10 kV (approximately 12 kV in reduced scan).
Geometry	Within 0.1 div of vertical and horizontal graticule lines.
BEAMFINDER	Actuating BEAMFINDER limits display to within graticule area.
STORAGE	
Stored Writing Speed Full Scan (Center 6 x 8 div at 0.9 cm/div) FAST VAR PERSIST FAST BISTABLE VAR PERSIST BISTABLE	300 div/ μ s (270 cm/ μ s). 50 div/ μ s (45 cm/ μ s). 2 div/ μ s (1.8 cm/ μ s). 0.03 div/ μ s (0.027 cm/ μ s).
Reduced Scan (Center 8 x 10 div at 0.45 cm/div) FAST VAR PERSIST FAST BISTABLE VAR PERSIST BISTABLE	5,500 div/ μ s (2,500 cm/ μ s). 776 div/ μ s (350 cm/ μ s). 12 div/ μ s (5.4 cm/ μ s). 0.2 div/ μ s (0.09 cm/ μ s).
Stored View Time BISTABLE and FAST BISTABLE VAR PERSIST and FAST VAR PERSIST AUTO ERASE VIEW TIME	At least 30 minutes (SAVE INTENSITY at MIN). 30 s or more at maximum persistence.
Minimum	Less than 1 s.
Maximum	Greater than 4 s.
REMOTE CONNECTORS & SWITCHES	
CONTROL ILLUMINATION	High, medium and off. (Three position switch located on rear of instrument).

TABLE 1-4 (CONT.)
Electrical Characteristics

Characteristics	Performance Requirement
REMOTE RESET INPUT	Input for reset of single-sweep function of time-base units installed in A and B HORIZ compartments (compatible time-base units only).
Signal Required	Switching from high level (+15 V to +10 V; sink less than 40 μ A) to low level (+0.5 V to -15 V; sink less than 10 mA), in less than 1 ms, resets the sweep.
Minimum Pulse Width	10 μ s at 50% amplitude points.
Maximum Input Voltage	+ or -15 V (dc plus peak ac).
PROBE POWER	2 probe power connectors.
REMOTE STORAGE GATE INPUT	Allows remote operation of high speed transfer. Low- to high-level transition enables High Speed Target to receive information to be stored. High-to-low transition initiates transfer from High Speed Target to Storage Target.
Signal Required	TTL voltage compatible.
Rise Time	1 μ s or less.
Fall Time	1 μ s or less.
Minimum Pulse Width	50 ns at 50% amplitude.
Input Resistance	Greater than 15 k Ω from -0.6 to +5 V input.
Input Capacitance	Approximately 100 pF.
Open Circuit Voltage	Approximately 0 V.
Maximum Input Voltage	+ or -15 V (dc plus peak ac)
REMOTE ERASE INPUT	Allows remote erasure of stored display. High-to-low transition initiates an erase cycle when in a storage mode.
Signal Required	TTL voltage compatible.
Rise Time	1 ms or less.
Fall Time	10 μ s or less.
Minimum Pulse Width	1 ms at 50% amplitude.
Input Resistance	Greater than 27 k Ω .
Input Capacitance	Approximately 100 pF.

TABLE 1-4 (CONT.)
Electrical Characteristics

Characteristic	Performance Requirement
Open Circuit Voltage	
In Nonstore Mode	Approximately 0 V.
In Store Mode	Approximately +5.6 V.
Max Input Voltage	+ or –15 V (dc plus peak ac).
REMOTE SAVE INPUT	Allows remote control of save mode. High state allows control from front panel. Low state holds storage circuitry in save mode when in storage mode.
Signal Required	TTL voltage compatible.
Rise Time	1 ms or less.
Fall Time	1 ms or less.
Open Circuit Voltage	Approximately 2.5 V.
Input Resistance	Approximately 10 k Ω .
Input Capacitance	Approximately 100 pF.
Maximum Input Voltage	+ or –15 V (dc plus peak ac).
POWER SOURCE	
Voltage Range (ac, rms)	Selected by rear-panel LINE VOLTAGE SELECTOR switch.
115 V Nominal	From 90 V to 132 V.
230 V Nominal	From 180 V to 250 V.
Line Frequency	From 48 Hz to 440 Hz.
Maximum Power Consumption	215 W.
Maximum Current	
90 V Input	3.3 A at 60 Hz.
180 V Input	1.7 A at 60 Hz.
Fuse Data (F1200)	See Electrical Parts list.

**TABLE 1-5
Environmental**

Characteristic	Information
----------------	-------------

NOTE

This instrument will meet the electrical characteristics given in the Performance Requirement column of Table 1-4 over the following environmental limits.

Temperature Range	
Operating	0° to +50° C.
Nonoperating	−55° to +75° C.
Altitude	
Operating	15,000 feet.
Nonoperating	Test limit 50,000 feet.
EMC (Electro Magnetic Compatibility) in accordance with MIL-STD-462A (when equipped with Option 3)	NOTE <i>Any unused plug-in compartments must be covered with a blank plug-in panel (EMC shielded) in order to meet EMC specifications. See Instrument Options section for additional information.</i>
Radiated Interference	Interference radiated from the instrument under test within the given limits from 150 kHz to 1000 MHz.
Conducted Interference	Interference conducted out of the instrument under test through the power cord within the given limits from 150 kHz to 25 MHz.
Transportation (packaged instrument, without plug-ins)	Qualifies under National Safe Transit Committee test procedure 1A, Category 11.

General Information—7834

TABLE 1-6
Physical

Characteristic	Information
Ventilation	Safe operating temperature maintained by dc fan. Automatic resetting thermal cutout protects instrument from overheating.
Warm-up Time	30 minutes for rated accuracy.
Finish	Anodized front- and rear-panel with blue-vinyl painted aluminum cabinet.
Overall Dimensions (measured at maximum points); see Fig. 1-1 for dimensional drawing.	
Height	13.6 inches 34.5 cm
Width	12.0 inches 30.5 cm
Length	23.2 inches 58.9 cm
Net Weight (Instrument Only)	37.5 lbs. 17.0 kg

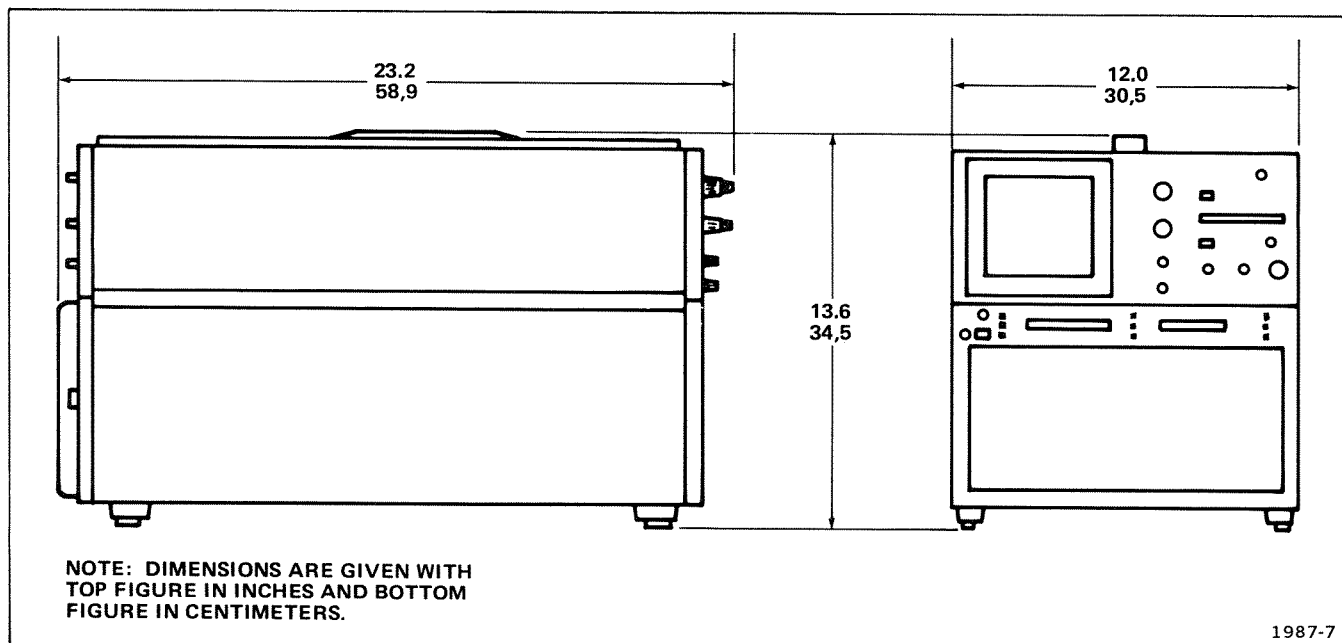

Figure 1-1. 7834 dimensional drawing.

SYSTEM ELECTRICAL SPECIFICATION

Your Tektronix 7834 Oscilloscope System provides exceptional flexibility in operation with a wide choice of general- and special-purpose plug-in units. The type number of a particular plug-in unit identifies its usage as follows:

The first digit (7) denotes the oscilloscope system for which the plug-in is designed (7000-series).

The second letter describes the purpose of the plug-in unit:

A—Amplifier	L—Spectrum Analyzer
B—Time base (real time)	M—Miscellaneous
C—Curve Tracer	S—Sampling
D—Digital	T—Time base (sampling)

The third and fourth digits of the plug-in type number do not carry any special connotation.

An "N" suffix letter added to the normal four-digit type number identifies a unit not equipped with the circuitry necessary to encode data for the 7000-series readout system.

Table 1-7 lists the vertical specifications which are system dependent. For more complete specifications on plug-in units for the 7000-Series Oscilloscope System, refer to the Tektronix Products catalog.

Table 1-8 lists the horizontal specifications which are system dependent. For more complete specifications on plug-in units for the 7000-Series Oscilloscope System, refer to the Tektronix Products catalog.

TABLE 1-7
7834 Oscilloscope
Vertical System Specification

Amplifier Plug-In Unit	Probe	Bandwidth (MHz)	Rise Time (ns)	Accuracy ¹		VERT SIG OUT	
				EXT CAL 0° to +50° C (%)	INT CAL 0° to +50° C (%)	BW (MHz)	Tr (ns)
7A11	Integral	200	1.8	2	3	135 MHz	2.6 ns
7A12	None	105	3.4	2	3	105 MHz	3.4 ns
	P6053B			3	4		
7A13	None	100	3.5	1.5	2.5	100 MHz	3.5 ns
	P6053B					100 MHz	3.5 ns
	P6055	65	5.4			65 MHz	5.4 ns
7A14	P6021	55	6.4	2	3	50 MHz	7.0 ns
	P6022	110	3.2			100 MHz	3.5 ns
7A15A/N	None	80	4.4	2	3	70 MHz	5.0 ns
	P6053A			3	4		
7A16A	None	200 ²	1.8 ²	2	3	135 MHz	2.6 ns
	P6053B			3	4		
7A17	None	150	2.4			15 MHz	24 ns
7A18	None	75	4.7	2	3	70 MHz	5.0 ns
	P6053B			3	4		
7A19	None	400 ²	0.9 ²	3	4	235 MHz	1.5 ns
	P6056			4	5		
	P6057						
	P6201	375 ²	1.0 ²	4	5		
7A19 (10 mV/Div Only)	None	325	1.1	3	4	235 MHz	1.5 ns
	P6056, P6057			4	5		
	P6201			300	1.2		
7A22	None or Any	1 MHz (within 10%)	350 (within 9%)	2	3	1.0 MHz ±10%	350 ns ±9%
7A24	None	300 ²	1.2 ²	3	4	135 MHz	2.6 ns
	P6056, P6057			4	5		
	P6201	275 ²	1.3 ²	4	5		
7A26	None	180 ²	1.9 ²	2	3	135 MHz	2.6 ns
	P6053B			3	4		

¹ Deflection Factor accuracy is checked as follows:
 EXT CAL 0° to +50° C: Plug-in gain set at a temperature within 10° C of operating temperature, using an external calibrator with accuracy within 0.25%.
 INT CAL 0° to +50° C: Plug-in gain set using the oscilloscope calibrator (within 10° C of the operating temperature) in a temperature range between 0° and +50° C.

² System temperature range from 0° to +35° C; derate 10% from +35° to +50° C.

TABLE 1-8
7834 Oscilloscope
System Horizontal Specification

Time-Base Unit	Performance Feature	Maximum Calibrated Sweep Rate	Triggering Frequency Range
7B50A	Delayed Sweep	5 ns/div	Dc to 150 MHz
7B70	Delayed Sweep	2 ns/div	Dc to 200 MHz
7B71	Dual Sweep Delaying and Delayed	2 ns/div	Dc to 200 MHz
7B92A	Display Switching	1 ns/div	Dc to 500 MHz
7B80	Delayed Sweep	1 ns/div	Dc to 400 MHz
7B85	Delaying Sweep	1 ns/div	Dc to 400 MHz

TABLE 1-9
Special Purpose Plug-In Units

Plug-In Unit	Performance Feature
7CT1N	Low-Power Semiconductor Curve Tracer
7D01	Logic Analyzer
7D10	Digital Events Delay
7D11	Digital Delay
7D12	A/D Converter; plug-in modules provide flexible measurement capability
7D13	Measures Temperature, Voltage, Current and Resistance
7D14	Directly Gated Counter to 525 MHz
7K11	CATV Preamplifier
7L12	100 kHz to 1.8 GHz Spectrum Analyzer
7L13	1 kHz to 1.8 GHz Spectrum Analyzer
7M11	Dual Delay Line
7M13	Readout Access Unit
7S11	Accepts Plug-In Sampling Heads
7S12	Time Domain Reflectometer and Sampling Applications
7S14	Dual Trace Delayed Sweep Sampler
7T11	Random or Sequential; equivalent or Real-Time Sampling

STANDARD ACCESSORIES

- 1 each Operators Manual
- 1 each Instruction Manual
- 1 each Grey Faceplate Filter (installed)
- 1 each Storage Green Faceplate Filter
- 1 each Power Cord

RECOMMENDED ACCESSORIES

The following accessories have been selected from our catalog specifically for your instrument. They are listed as a convenience to help you meet your measurement needs. For detailed information and prices, refer to a Tektronix Products Catalog or contact your local Tektronix Field Representative.

CAMERAS

C-5A: The C-5A is a low-cost general-purpose camera with a Polaroid Pack-Film Back, pulsed graticule illumination, and a fixed f/16 lens. Magnification may be set at 0.67 or 0.85.

Order C-5A

C-5A Opt. 1: The C-5A Opt. 1 camera is the C-5A without the pulsed graticule illumination feature.

Order C-5A Opt. 1

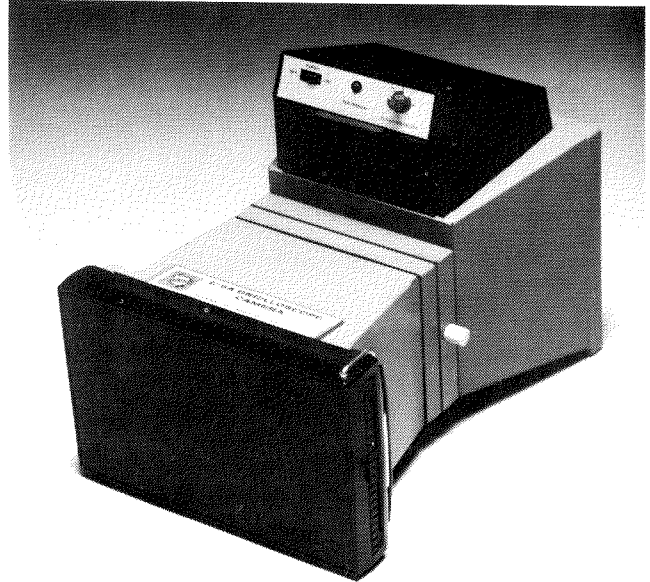

C-52: Electronically-controlled shutter allows remote, automatic, or manual shutter actuation. Automatic single-sweep control simplifies single-event photography. Photometer exposure aid provides an easy way to estimate exposure for repetitive or stored traces. Range-finder focusing permits refocusing without removing the film.

Order, Polaroid pack film C-52P

Order, Polaroid roll film C-52R

Order, Sheet or roll film holders. C-52G

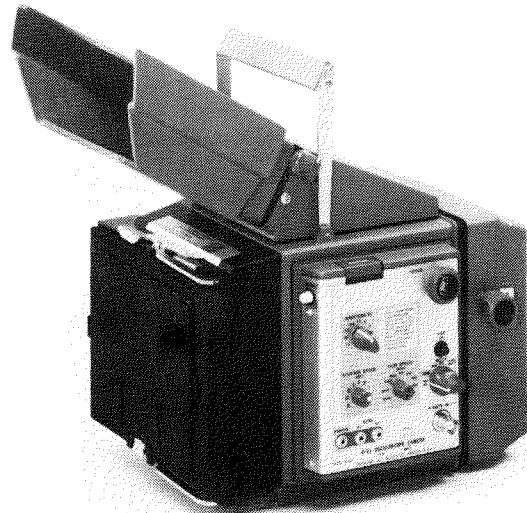

General Information—7834

C-58: The C-58 is a general-purpose camera. The F/2.8 lens takes full-size photos where fast writing speed is not necessary.

- Order, Polaroid pack film C-58P**
- Order, Polaroid roll film C-58R**
- Order, Sheet or roll film holders. C-58G**

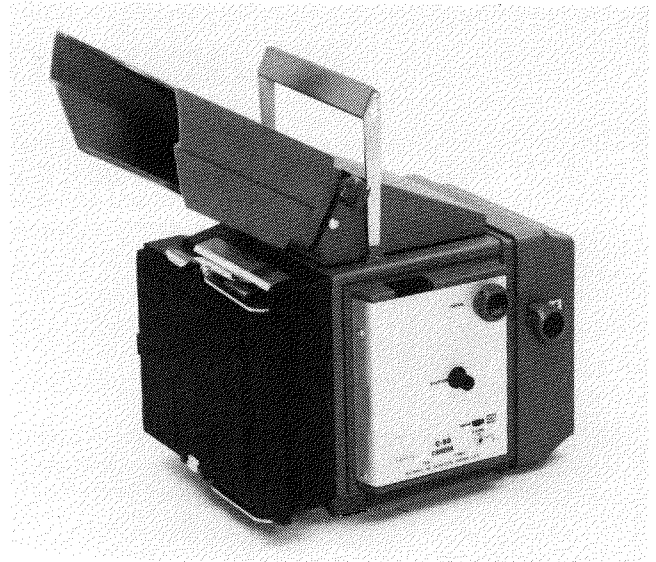

CART

TEK LAB CART MODEL 3: Mobile equipment cart with 14" X 21" top tray, lockable storage drawer, and extra instrument tray.

Order TEK LAB CART MODEL 3

Extra shelf.

Order 436-0132-01

Optional Safety Belt.

Order 346-0136-01



OPERATING INSTRUCTIONS

PRELIMINARY OPERATION

To operate this instrument effectively, the user must become familiar with the operation and capabilities of the instrument. This section describes how to use the front- and rear-panel controls and connectors.

WARNING

To avoid electric-shock hazard, see Installation in the General Information section of this manual before operating this instrument.

PLUG-IN UNITS

The 7834 accepts up to 4 Tektronix 7000-Series plug-in units. This feature allows selection of bandwidth, sensitivity, display mode, etc., and provides for future expansion of the system.

The overall capabilities of the system are mainly determined by the characteristics of the selected plug-ins. Some typical combinations are given under Applications, in this section, along with simplified setup instructions. For information on other plug-in units, refer to the current Tektronix Products catalog.

Installation of Plug-In Units

CAUTION

Plug-in units should not be installed or removed without first turning the instrument power off, to prevent instrument damage.

To install a plug-in unit into a compartment, align the slots in the top and bottom of the plug-in unit with the associated guide rails in the plug-in compartment. Insert the plug-in unit into the compartment until it locks into place. To remove a plug-in unit, pull out on the release latch to disengage the plug-in. To meet the EMC (electromagnetic compatibility) specifications, cover all unused plug-in compartments with an EMC shielded blank plug-in panel, Tektronix Part 016-0155-00.

The gain of the 7834 vertical and horizontal systems has been normalized to allow plug-in units to be interchanged among plug-in compartments without adjustment of the system. The basic calibration of the plug-in units should be checked when installed to verify their accuracy (refer to the operating instructions in the plug-in manual).

CONTROLS AND CONNECTORS

The 7834 front and rear panels are shown in Figure 2-1 and Figure 2-2. A brief, functional description of each control and connector is included in the illustration. Refer to Detailed Operating Information for additional information.

Front-Panel Color Coding

The 7834 front panel has color coded areas. These colors define areas by function. Blue identifies controls that affect the display mode; green identifies triggering controls.

Other colors such as gray, orange and yellow, have no functional assignment, but indicate the relationships among controls and/or connectors.

FUNCTIONAL CHECK

The following Functional Check procedure can be used for incoming inspection to verify proper operation, and may also be used by the operator for instrument familiarization. Only instrument functions (not measurement quantities or specifications) are checked in the procedure; therefore, a minimum amount of test equipment is required. If performing the Functional Check procedure reveals improper performance or instrument malfunction, first check the operation of associated equipment; then refer to qualified service personnel for repair or adjustment of the instrument.

Test Equipment Required

The following test equipment was used in preparing the Functional Check procedure. Other test equipment which meets these requirements may be substituted. When other equipment is substituted, the control settings or setup may need to be altered.

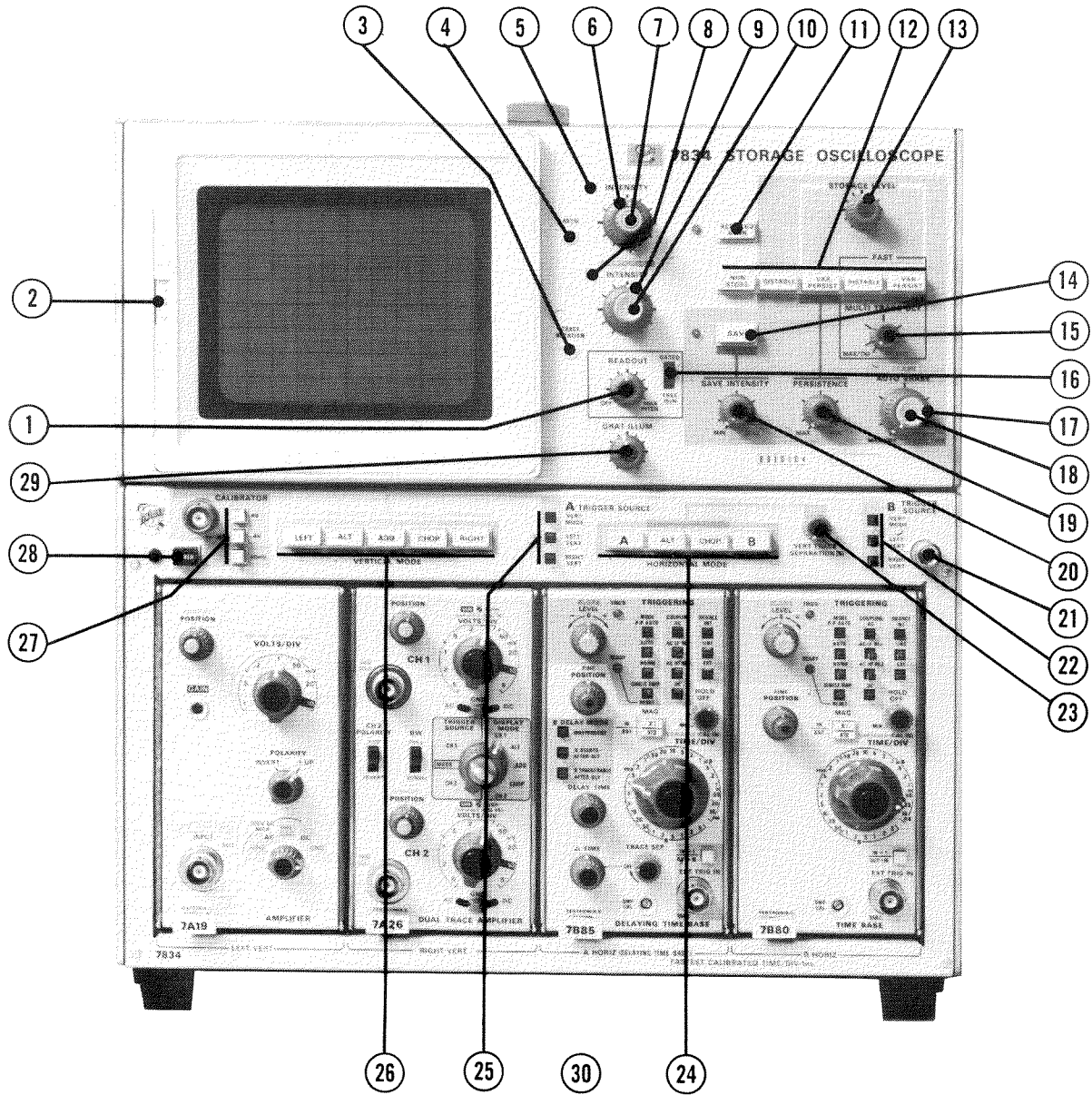

NOTE

HORIZONTAL SELECTOR SWITCH
LOCATED AT THE REAR OF THE
A HORIZ COMPARTMENT.

Figure 2-1. Front-panel controls, connectors and indicators.

FRONT-PANEL CONTROLS, CONNECTORS AND INDICATORS

- ① READOUT Intensity (Option 1 deletes Readout System)—Controls brightness of the readout display. Disables Readout System in counterclockwise detent position.
- ② Camera Power Connector (not labeled)—Three-pin connector provides power for camera operation and receives single-sweep-reset signal.
- ③ TRACE ROTATION—Screwdriver adjustment to align trace(s) with graticule lines.
- ④ ASTIG—Screwdriver adjustment used in conjunction with FOCUS control to obtain a well defined display.
- ⑤ A INTENSITY (Indicator)—Illuminates when selected by HORIZONTAL MODE switch.
- ⑥ A INTENSITY—Controls brightness of trace produced by the plug-in unit installed in the A HORIZ compartment.
- ⑦ FOCUS—Control optimizes crt trace definition.
- ⑧ B INTENSITY (Indicator)—Illuminates when selected by the HORIZONTAL MODE switch.
- ⑨ B INTENSITY—Controls brightness of the trace produced by the plug-in unit installed in the B HORIZ compartment.
- ⑩ BEAMFINDER—When pressed compresses and defocuses display within graticule area.
- ⑪ REDUCED SCAN—Calibrated area of crt is reduced to inner half-size graticule and stored writing speed is increased.
- ⑫ Storage Mode Switch (not labeled)—Selects 1 of 4 storage display modes or the NON-STORE display mode.
- ⑬ STORAGE LEVEL—Varies writing speed of FAST BISTABLE, VAR PERSIST, and FAST VAR PERSIST storage modes.
- ⑭ SAVE—Retains storage display in a nonerasable mode with continuously variable intensity.
- ⑮ MULTI TRACE DLY—Controls time between successive sweeps when operating in FAST BISTABLE and FAST VAR PERSIST storage modes.
- ⑯ READOUT Mode—Switch selects FREE RUN or GATED readout modes.
- ⑰ AUTO ERASE—Controls time of automatic erase viewtime.
- ⑱ ERASE—Erases stored display.
- ⑲ PERSISTENCE—Controls rate of continuous erasure of FAST VAR PERSIST and VAR PERSIST storage displays.
- ⑳ SAVE INTENSITY—Controls intensity of the SAVE display.
- ㉑ Ground (not labeled)—Binding post to establish common ground between associated equipment.
- ㉒ B TRIGGER SOURCE—Selects internal trigger source for B HORIZ plug-in unit.
- ㉓ VERT TRACE SEPARATION (B)—Vertically positions the B HORIZ trace with respect to the A HORIZ trace (dual-sweep modes only).
- ㉔ HORIZONTAL MODE—Selects input source for horizontal deflection.
- ㉕ A TRIGGER SOURCE—Selects internal trigger source for A HORIZ plug-in unit.
- ㉖ VERTICAL MODE—Selects input source for vertical deflection.
- ㉗ CALIBRATOR—Provides 1 kHz calibrated square-wave voltages.
- ㉘ POWER (Switch and Indicator)—Switch controls power to instrument; indicator illuminates when power is on.
- ㉙ GRAT ILLUM—Controls illumination of graticule lines.
- ㉚ Horizontal Selector—Three position Switch A, B, and Normal; A and B positions modify operation of HORIZONTAL MODE switch for FAST BISTABLE and FAST VAR PERSIST X-Y storage displays.

1987-1

Figure 2-1. Front-panel controls, connectors and indicators (continued).

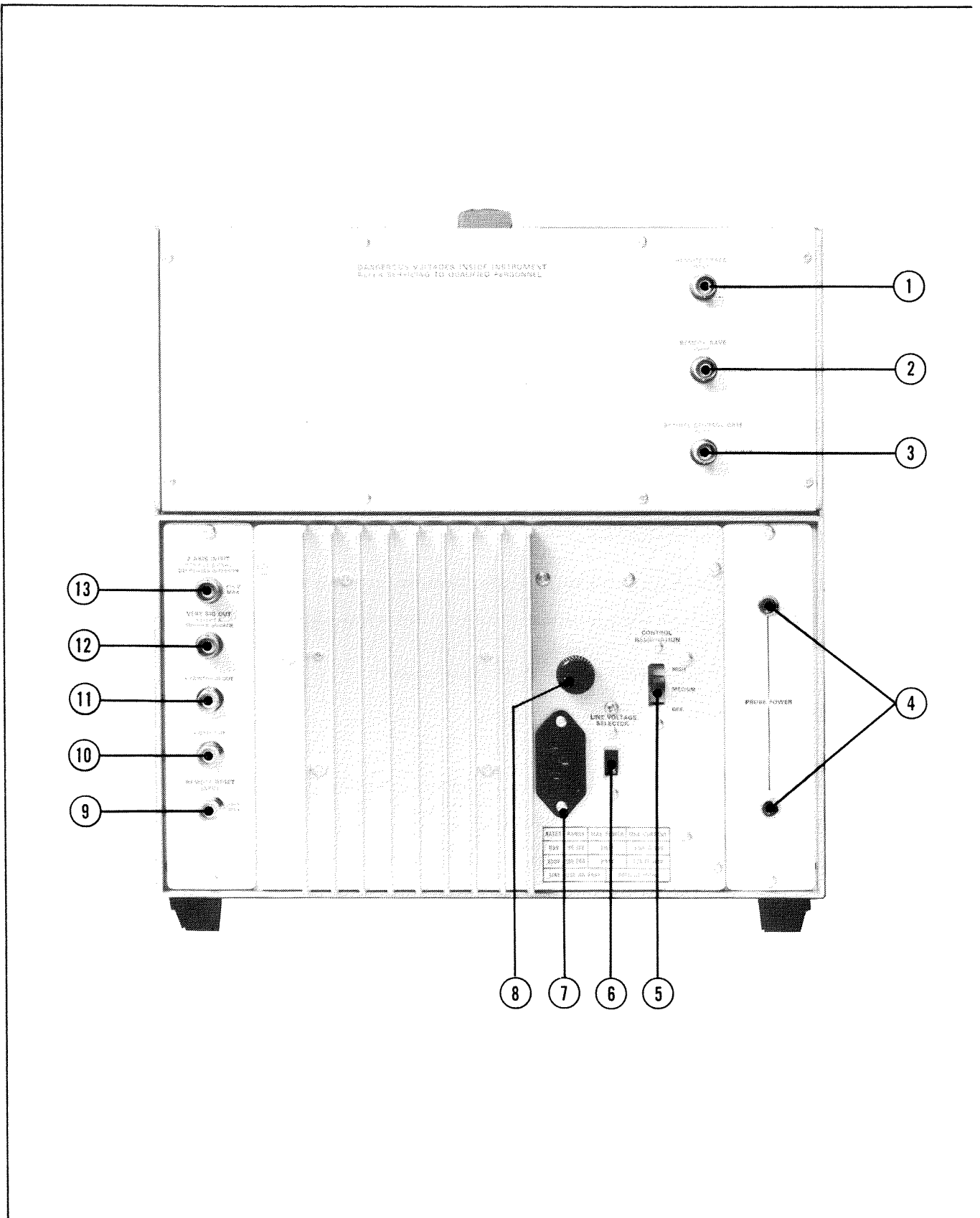

Figure 2-2. Rear-panel controls and connectors.

REAR-PANEL CONTROLS AND CONNECTORS

- ① REMOTE ERASE INPUT—Input for external operation of the ERASE function.
- ② REMOTE SAVE INPUT—Provides access for external operation of the SAVE function.
- ③ REMOTE STORAGE GATE INPUT—Input for external operation of the transfer function (FAST BISTABLE and FAST VAR PERSIST only).
- ④ PROBE POWER (2)—Connectors provide power to active probe system (deleted by Option 1).
- ⑤ CONTROL ILLUMINATION—Sets illumination level of the A and B INTENSITY indicators and of the lighted push-button switches on associated plug-in units.
- ⑥ LINE VOLTAGE SELECTOR—Sets instrument to 115-volt or 230-volt nominal line operation.
- ⑦ Power-input receptacle.
- ⑧ Line fuse receptacle.
- ⑨ REMOTE RESET INPUT—Input for activating single-sweep function of time-base unit(s).
- ⑩ +GATE OUT—Output signal derived from either the A Gate, B Gate, or the A Dly'd Gate.
- ⑪ +SAWTOOTH OUT—Sawtooth output signal derived from the A or B time-base unit.
- ⑫ VERT SIG OUT—Output signal derived from vertical signal as selected by A TRIGGER SOURCE switch.
- ⑬ Z-AXIS INPUT—Input for external intensity modulation of the crt display.

WARNING

The power-input plug must be inserted only into a mating receptacle with a grounding contact. Do not defeat the grounding connection. Any interruption of the grounding connection can create an electric shock hazard. Refer to qualified service personnel for verification of adequate protective grounding system to which this instrument is to be connected.

1987-2A

Figure 2-2. Rear-panel controls and connectors (continued).

Operating Instructions—7834

1. Function Generator

Description: Frequency range, 250 kilohertz to 1 megahertz; output amplitude, two volts peak-to-peak into 50 ohms; waveform, sine wave.

Type Used: Tektronix SG503 (used with TM500 power module).

2. Cables (2 Required)

Description: Length, 42 inches; connectors, BNC.

Type: Type RG-58/U, 50-ohm coaxial, Tektronix Part 012-0057-01.

3. T Connector

Description: Connectors, BNC to BNC.

Type Used: BNC-to-BNC connector, Tektronix Part 103-0030-00.

4. Adapter

Description: Connectors, BNC female to BNC female.

Type Used: BNC female-to-BNC female, Tektronix Part 103-0028-00.

Preliminary Set Up

1. Set the front-panel controls as follows:

A INTENSITY counterclockwise

FOCUS midrange

B INTENSITY counterclockwise

READOUT OFF

GRAT ILLUM counterclockwise

POWER off

CALIBRATOR 4 V

VERTICAL MODE LEFT

A TRIGGER SOURCE . . . VERT MODE

HORIZONTAL MODE . . . A

VERT TRACE SEPARATION (B) midrange

B TRIGGER SOURCE . . . VERT MODE

NON-STORE button in

REDUCED SCAN button out

HORIZONTAL

SELECTOR NORM (located at the rear of the A HORIZ compartment)

2. Connect the 7834 to a power source that meets the voltage and frequency requirements of this instrument. If the available line voltage is outside the limits of the Line Voltage Selector switch setting (on rear panel), see Operating Power Information under Installation (General Information Section).

3. Install Tektronix 7A-Series amplifier units in the LEFT VERT and RIGHT VERT compartments. Install Tektronix 7B-Series time-base units in the A HORIZ and B HORIZ compartments.

4. Press the POWER switch to the on (locked in) position.

5. Set both time-base units to 1 millisecond/division and triggering to auto mode with ac coupling from the internal source.

6. Rotate the A INTENSITY control until the trace is at a desirable viewing level (near midrange).

7. Connect the CALIBRATOR output to the input of the left amplifier unit with a 42-inch BNC cable.

8. Set the left amplifier deflection factor to display a signal amplitude of 2 divisions on the crt.

9. Set the A horizontal time-base triggering for a stable display.

Display Focus

10. Rotate the FOCUS and ASTIG controls and observe the square-wave display. Notice that the thickness of the trace varies. Set the FOCUS and ASTIG controls for a well-defined trace.

Trace Alignment

11. Disconnect the input signal. Use the left amplifier position control to align the trace with the center horizontal graticule line. If necessary use the TRACE ROTATION control to align the trace with the center graticule line.

Graticule Illumination

12. Rotate the GRAT ILLUM control throughout its range and notice that the graticule lines are illuminated as the control is turned clockwise.

Control Illumination

13. Notice that the A INTENSITY indicator and the lighted push-button switches are illuminated. Sequentially press all of the HORIZONTAL MODE switch positions and notice the A and B INTENSITY lights; these lights indicate which intensity control is active. Set the CONTROL ILLUM switch to the MEDIUM position. Observe that the selected intensity indicator and the lighted push-button switches on the plug-in units are dimmed.

14. Set the rear-panel CONTROL ILLUMINATION switch to the HIGH position. Return the HORIZONTAL MODE switch to A.

Vertical Deflection System

15. Connect the 4 V CALIBRATOR output to the input connectors of both amplifier units with two 42-inch BNC cables and a BNC T connector. Set the deflection factor of the left amplifier unit to display about 2 divisions of signal on the crt.

16. Notice that the position control of only the left amplifier unit affects the vertical position of the displayed trace. Position the trace to the upper half of the graticule.

17. Set the VERTICAL MODE switch to RIGHT. Set the deflection factor of the right amplifier unit to display about 2 divisions of signal on the crt.

18. Notice that the position control of only the right amplifier unit affects the vertical position of the displayed trace. Position the trace to the lower half of the graticule.

19. Set the VERTICAL MODE switch to ALT. Notice that 2 traces are displayed on the crt. The top trace is produced by the left amplifier unit and the bottom trace is produced by the right amplifier unit; the sweep for both traces is produced by the A time-base unit. Set the sweep rate of the A time-base unit to 50 milliseconds/division; notice that the

display alternates between the left and right amplifier plug-in units after each sweep. Turn the A time-base sweep rate switch throughout its range; notice that the display alternates between amplifier units at all sweep rates.

20. Set the VERTICAL MODE switch to CHOP. Turn the A time-base unit sweep rate switch throughout its range. Notice that a dual-trace display is presented at all sweep rates, and that both amplifier units are displayed by the A time-base unit on a time-sharing basis. Set the A time-base unit sweep rate switch to 0.5 millisecond/division.

21. Set the VERTICAL MODE switch to ADD. The display should be four divisions in amplitude. Notice that the position control of either amplifier unit moves the display. Set the VERTICAL MODE switch to LEFT.

Horizontal Deflection System

22. Notice that the position control of only the A time-base unit affects the horizontal position of the displayed trace. Position the start of the trace to the left graticule line with the A time-base unit position control.

23. Set the HORIZONTAL MODE switch to B. Advance the B INTENSITY control until the display becomes defocused. The defocused display indicates that the B INTENSITY control is set too high. Reduce the setting of the B INTENSITY control to obtain a bright, well-defined display.

24. Notice that the position control of only the B time-base unit affects the horizontal position of the displayed trace. Position the start of the trace to the left graticule line with the B time-base unit position control.

25. Set the HORIZONTAL MODE switch to ALT. Two traces should be presented on the crt. If the traces overlap, adjust the VERT TRACE SEPARATION (B) control to position one trace to the bottom of the graticule area. Turn the sweep rate switches of both time-base units throughout their range. Observe that each time-base unit controls one of the traces independently of the other time-base unit. Also notice that when one of the time-base units is set to a slow sweep rate (below about 50 milliseconds/division), sweep alternation is evident (only 1 of the traces is presented on the crt at a time). Set the sweep rates of both time-base units to 0.5 millisecond/division. Adjust the A INTENSITY control; notice that it changes the intensity of the trace produced by the A time-base unit only. Likewise, the B INTENSITY control changes the intensity of the trace produced by the B time-base unit only. Return both intensity controls to desirable levels.

Operating Instructions—7834

26. Set the HORIZONTAL MODE switch to CHOP. Notice that two traces are displayed on the crt in a manner similar to that of the ALT display. Turn the sweep rate switches of both time-base units throughout their ranges. Observe that two traces are displayed on the crt at all sweep rates. Also notice that when both time-base units are set to a slow sweep rate (50 milliseconds/division or slower), both traces are visible on the crt at the same time. Return the sweep rate switches of both time-base units to 0.5 millisecond/division.

27. Set the CALIBRATOR switch to 0.4 V. Set the VERTICAL MODE switch to CHOP. Four traces should be displayed on the crt. If not, adjust the position controls of the amplifier units and the VERT TRACE SEPARATION (B) control to position the four traces into view. Set the position controls of the plug-in units to identify which trace is produced from each plug-in unit (if amplifier units have the identify feature, it can be used to identify the traces). Set the A time-base unit for a sweep rate of 1 millisecond/division. Notice that the left-amplifier unit is displayed at the sweep rate of both the A and B time-base units and that the right-amplifier unit is also displayed at the sweep rate of both time-base units.

28. Set the HORIZONTAL MODE switch to ALT. Observe that the display is very similar to that obtained in the previous step. The main difference in this display is that the traces are now displayed alternately (noticeable only at slow sweep rates).

29. Set the VERTICAL MODE switch to ALT. Set the CALIBRATOR switch to 4 V. Notice that the trace produced by the left amplifier unit is displayed at the sweep rate of the B time-base unit and the trace produced by the right amplifier unit is displayed at the A time-base unit sweep rate. This feature is called independent-pairs operation and is obtained only when the VERTICAL MODE switch is in the ALT position and the HORIZONTAL MODE switch is in either the ALT or the CHOP position.

Triggering

30. Set the VERTICAL MODE switch to LEFT and the HORIZONTAL MODE switch to A. Center the display on the crt with the left amplifier unit position control. Disconnect the input signal from the right amplifier unit input connector. Sequentially select all of the VERTICAL MODE switch positions. Notice that a stable display is obtained for all positions of the VERTICAL MODE switch (straight line in RIGHT switch position).

31. Set the A TRIGGER SOURCE switch to LEFT VERT. Again, sequentially select all of the VERTICAL MODE switch positions. Notice that the display is again stable in all positions, as in the previous step.

32. Set the A TRIGGER SOURCE switch to RIGHT VERT. Sequentially select all of the VERTICAL MODE switch positions and notice that a stable display cannot be obtained in any position (this is because there is no input signal connected to the right vertical unit). Return the A TRIGGER SOURCE switch to VERT MODE.

33. The B TRIGGER SOURCE switch operates in a manner similar to the A TRIGGER SOURCE switch when the B time-base unit is selected to provide the display. Set the B TRIGGER SOURCE switch to VERT MODE.

34. Set the HORIZONTAL MODE switch to ALT or CHOP. Notice that this is the same display obtained in step 29 (independent-pairs operation).

Readout

NOTE

The following 3 steps apply only to instruments equipped with Readout; for Option 1 instruments proceed to step 38.

35. Turn the READOUT control clockwise until an alphanumeric display is visible within the top or bottom division of the crt. Change the deflection factor of the amplifier unit that is selected for display; notice that the readout position of the display changes as the deflection factor is changed. Likewise, change the sweep rate of the time-base unit which is selected for display; notice that the readout display for the time-base unit changes as the sweep rate is changed.

36. Set the time-base unit for X10 magnification. Notice that the readout display changes to indicate the correct magnified sweep rate. If a readout-coded 10X probe is available for use with the amplifier unit, install it on the input connector of the right amplifier plug-in unit. Notice that the deflection factor indicated by the readout is increased by 10 times when the probe is added. Return the time-base unit to normal sweep operation and disconnect the probe.

37. Sequentially select all of the VERTICAL MODE and HORIZONTAL MODE switch positions. Notice that the readout from a particular plug-in occupies a specific location on the display area. If either of the vertical plug-in units is a dual-trace unit, notice that the readout for channel 2 appears within the lower division of the crt. Return the VERTICAL MODE switch to LEFT and the HORIZONTAL MODE switch to A. Set the READOUT control to OFF.

Beamfinder

38. Set the deflection factor of the left amplifier unit to 0.1 volt/division. Notice that a square-wave display is not visible, since the deflection exceeds the scan area of the crt.

39. Press the BEAMFINDER push-button switch; notice that the display is returned to the viewing area in compressed form. Release the BEAMFINDER switch and notice that the display again disappears from the viewing area.

40. With the BEAMFINDER switch pushed in, increase the amplifier-unit deflection factor until the display is reduced to about 2 divisions vertically. Adjust the position control of the displayed amplifier unit to position the compressed display near the center of the graticule. Release the BEAMFINDER switch and notice that the display remains within the viewing area.

Calibrator

41. Connect the CALIBRATOR output to both the left and right vertical units with two BNC cables and a BNC T connector. The display amplitude should be approximately 2 divisions. If not, adjust the deflection factor accordingly.

42. Select different CALIBRATOR push buttons (labeled 4 V, 0.4 V, 40 mV, and 4 mV) and notice that the displayed signal changes accordingly (CALIBRATOR output must be terminated into more than a 100 kilohm load for stated output). When the CALIBRATOR output is terminated into 50 ohms, the output is 0.1 times the stated output.

Z-Axis Input

43. If an external signal is available (2 volts peak-to-peak minimum), the function of the Z-AXIS INPUT can be demonstrated. Connect the external signal to both the input connector of the displayed amplifier unit and the Z-AXIS INPUT connector. Set the sweep rate of the displayed time-base unit to display about 5 cycles of the signal. Set the amplitude of the signal generator until intensity modulation is visible on the display (change the amplifier unit deflection factor as necessary to produce an on-screen display). The positive peaks of the waveform should be blanked out and the negative peaks intensified. Notice that the setting of the intensity controls determines the amount of intensity modulation that is visible. Disconnect the cables.

Storage Operation

44. Connect the 4 V CALIBRATOR output to the input connector of the left amplifier unit and set the deflection factor for a 2-division display. Set the time-base unit triggering mode to single sweep and set the sweep rate for 0.5 millisecond/division.

45. Press the BISTABLE push button and set the AUTO ERASE control fully counterclockwise into the detent position.

46. Press the ERASE push button. The calibrator signal should be stored on the crt. If not, increase the A INTENSITY control slightly and press the ERASE button again. Repeat this sequence until a stored display is obtained.

47. Press the SAVE push button. The signal stored in the previous step should remain on the crt; it may be necessary to adjust the SAVE INTENSITY control to view the display. Turn the SAVE INTENSITY control throughout its range and observe the effect on the display.

48. Press the ERASE button and notice that the display cannot be erased (the SAVE mode inhibits the erase function). Press and release the SAVE push button.

49. Set the STORAGE LEVEL and the PERSISTENCE controls fully counterclockwise. Press the VAR PERSIST push button. Observe that an erase cycle and sweep occurs (when switching between the BISTABLE and VAR PERSIST modes) and that the screen goes dark except for the stored display.

50. Slowly turn the PERSISTENCE control clockwise and notice that the stored display fades into the background (background lighting will be observed as the PERSISTENCE control is advanced clockwise). The PERSISTENCE control determines the time interval during which the stored display is retained in the VAR PERSIST mode. Set the PERSISTENCE control fully counterclockwise.

51. Press the ERASE push button, then set the PERSISTENCE control to midrange just long enough for the display to fade out. Quickly turn the PERSISTENCE control fully counterclockwise. Slowly increase the STORAGE LEVEL (clockwise) and notice that the faded display again becomes visible, against the background.

Operating Instructions—7834

52. Turn the PERSISTENCE, STORAGE LEVEL, and A INTENSITY controls fully counterclockwise and set the time-base unit for auto triggering at a sweep rate of 0.5 second/division.
53. Set the PERSISTENCE control to midrange and slowly increase the A INTENSITY (clockwise) until the trace appears. Vary the PERSISTENCE control setting and notice that the trace can be made to build up or to fade more quickly, depending on the control setting. Varying the A INTENSITY control also affects the display in the same manner. Return the PERSISTENCE control to midrange and slowly decrease the A INTENSITY control to the point where the trace is just extinguished; then set the STORAGE LEVEL control fully clockwise and notice that the trace becomes visible again.
54. Turn the PERSISTENCE, STORAGE LEVEL, and A INTENSITY controls fully counterclockwise and set the time-base unit for auto triggering at a sweep rate of 0.5 millisecond/division.
55. Press the FAST BISTABLE push button.
56. Press the ERASE push button and notice that the screen background appears to alternate between bright and dim. This indicates that the sweep and transfer functions are operating.
57. Set the MULTI TRACE DLY control fully clockwise; then, slowly increase the A INTENSITY control (clockwise) until the display stores. Notice that each sweep is stored without erasing the previously stored sweep. This is easily observed if the vertical position control is varied between sweeps.
58. Press the ERASE push button and notice that the display is erased.
59. Set the time-base unit for single sweep and press the ERASE push button. Notice that only one sweep is stored (trigger time-base unit if necessary).
60. Change the setting of the vertical position control and initiate another sweep by pressing the reset button on the time-base unit. Notice that the new sweep is stored along with the one stored in the previous step.
61. Alternately press the ERASE push button and reduce the A INTENSITY control to the point where the display just fails to store.
62. Alternately increase the STORAGE LEVEL (clockwise) and press the ERASE push button. Notice that as the STORAGE LEVEL is increased, the display begins to store.
63. The FAST VAR PERSIST mode operates exactly as outlined for the VAR PERSIST mode except that the sweep and transfer functions are operative as described for FAST BISTABLE operation.
64. Set the time-base unit for auto triggering and set the 7834 for BISTABLE operation.
65. Set the A INTENSITY control to its 1 o'clock position. Turn the ERASE control out of the detent position and notice that erase cycles occur automatically and with increasing frequency as the control is turned clockwise.
66. Return the ERASE control to the detent (OFF) position and set the time-base unit for single sweep and external triggering. Turn the SAVE INTENSITY control fully counterclockwise.
67. Press the ERASE push button; notice that no sweep occurs.
68. Press the SAVE push button; notice that no sweep occurs (this is the "Auto Save" mode). Since no trigger was available, the sweep did not run; therefore, the system waits in a ready-to-store mode.
69. Set the time-base unit to internal trigger and notice that the screen goes dark. This indicates that a sweep has occurred and that the system has entered the SAVE mode.
70. Turn the SAVE INTENSITY control clockwise and notice that the stored display becomes visible.
71. Press the NON-STORE push button and set the time-base unit for auto triggering.

DETAILED OPERATING INFORMATION

WARNING

Do not remove the clear plastic implosion shield covering the crt face plate; the crt implosion shield provides protection to the operator from crt implosion.

Graticule

The graticule is marked on the inside of the crt faceplate, providing accurate, parallax-free measurements. The graticule is divided into eight vertical and ten horizontal divisions. Each Full Scan division is a 0.9-centimeter square divided into five minor divisions. A Reduced Scan graticule is etched in the center of the Full Scan graticule. Each Reduced Scan division is exactly one-half of a Full Scan division (0.45 centimeter). The vertical gain and horizontal timing of the plug-in units are calibrated to the graticule so that accurate measurements can be made from the crt. The illumination of the graticule lines can be varied with the GRAT ILLUM control.

Figure 2-3 shows the graticule and defines the various measurement lines. The terminology defined here will be used in all discussions involving measurements from the graticule. Notice the 0%, 10%, 90%, and 100% markings on the left side of the graticule. These markings are provided to facilitate rise-time measurements.

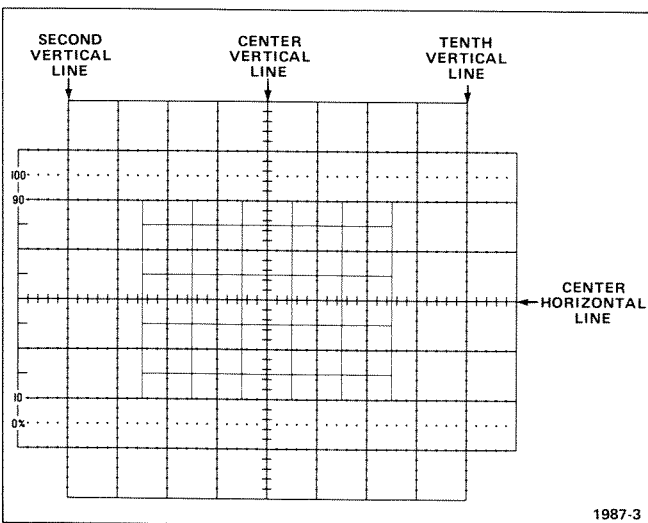

Figure 2-3. Definition of graticule measurement lines.

Light Filter

The tinted crt face-plate filter minimizes light reflections from the face of the crt to improve contrast when viewing the display under high-ambient-light conditions. This filter may be removed for waveform photographs or for viewing high-writing-rate displays. To remove the filter, pull outward on the bottom of the plastic crt mask and remove it from the crt bezel. Remove the tinted filter; leave the clear plastic face-plate protector installed and replace the mask. The face-plate protector should be left in place at all times to protect the crt face plate from scratches.

An optional mesh filter is available from Tektronix (included with Option 3). This filter provides shielding against radiated EMC (electromagnetic compatibility) from the face of the crt. It also serves as a light filter to make the trace more visible under high-ambient-light conditions. The mesh filter fits in place of the plastic tinted filter. Order the filter by Tektronix Part 378-0603-00.

Control Illumination

The CONTROL ILLUMINATION switch sets the illumination level of the A and B INTENSITY indicators, the A and B TRIGGER SOURCE switches, and of the lighted push button switches on the plug-in units. The positions available are OFF, MEDIUM, and HIGH. This switch is located on the rear panel of the 7834. The CONTROL ILLUMINATION switch does not affect the function-indicator lights (such as triggered or single-sweep ready lights).

Intensity Controls

The A INTENSITY control determines the brightness of the display produced by the plug-in unit installed in the A HORIZ compartment; the B INTENSITY control determines the brightness of the display produced by the plug-in unit installed in the B HORIZ compartment. The READ-OUT intensity control affects the brightness of only the readout portion of the crt display.

CAUTION

Crt damage can occur under adverse conditions. Avoid any condition where an extremely bright, sharply-focused dot exists on the crt. Also, remember that the light filter reduces the apparent light output from the crt.

The beam current is limited during X-Y mode operation or when either, or both, time-base units being displayed are set for a slow sweep rate. This reduces the danger of damaging the crt with a stationary or slowly moving spot.

Display Focus

This instrument contains an automatic-focusing circuit which maintains optimum focus for all intensity settings after a correct setting of the FOCUS control is established. The easiest way to obtain the correct setting of the FOCUS control is to set the READOUT intensity control so that the readout portion of the display is clearly visible. Then adjust the FOCUS control for best definition of the readout display. If the instrument does not contain the Readout System (Option 1), set the FOCUS control for best definition of the crt display at a low intensity setting.

Astigmatism-Focus Adjustments

If a well-defined display cannot be obtained with the FOCUS control, adjust the ASTIG adjustment as follows:

NOTE

To check for proper setting of the ASTIG adjustment, slowly turn the FOCUS control through the optimum setting. If the ASTIG adjustment is correctly set, the vertical and horizontal portions of the display will focus at the same position of the FOCUS control. This setting of the ASTIG adjustment should be correct for any display.

1. Install an amplifier unit in the LEFT VERT compartment and a time-base unit in the A HORIZ compartment.
2. Set the VERTICAL MODE switch to LEFT and the HORIZONTAL MODE switch to A.
3. Connect the output of a sine-wave generator to the input of the amplifier unit. Set the sine-wave generator repetition rate to 1 kilohertz and the vertical amplifier deflection factor for a 2-division display.
4. Set the time-base unit sweep rate for 0.2 millisecond/division and the triggering for a stable display. Set the A INTENSITY control so the display is at a usable intensity level (about midrange).
5. Turn the FOCUS control fully counterclockwise and set the ASTIG adjustment to midrange.
6. Set the FOCUS control so the thickness of the sine-wave trace is as thin as possible.

7. Adjust the ASTIG adjustment so the width of the sine-wave trace is as thin as possible.

8. Repeat steps 6 and 7 for the best overall focus.

Beamfinder

The BEAMFINDER helps to locate a display that overscans the crt viewing area vertically and/or horizontally. When the BEAMFINDER button is pressed, the display is compressed and defocused within the graticule area. To locate and reposition an overscanned display, use the following procedure:

1. Press the BEAMFINDER push button while the display is compressed, change the vertical and horizontal deflection factors until the vertical deflection is about two divisions high and the horizontal deflection is about four divisions wide (the horizontal deflection needs to be reduced only when operating in an X-Y mode).
2. Adjust the vertical and horizontal position controls to center the display on the graticule.
3. Release the BEAMFINDER push button; the display should remain within the graticule area.

Trace Alignment

The TRACE ROTATION control allows the trace to be aligned with the horizontal graticule lines. To set the control, position the trace to the center horizontal line and adjust the TRACE ROTATION control so that the trace is parallel with the center horizontal graticule line.

Readout Display

NOTE

Option 1 deletes the Readout System and probe power connectors from the instrument; disregard the following information for Option 1 instruments.

The Readout System provides an alpha-numeric display of information on the crt along with the analog waveform display. The information displayed by the Readout System is obtained from the plug-in units installed in the plug-in compartments.

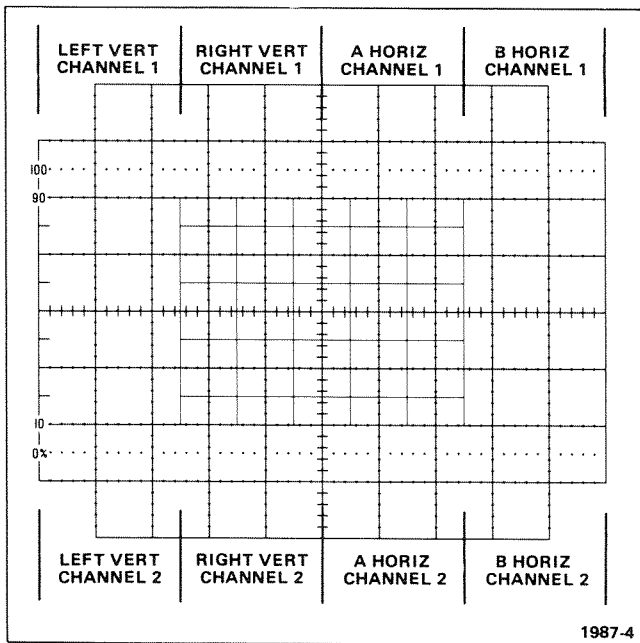

Figure 2-4. Location of readout on the crt identifying the originating plug-in and channel.

The readout information from each channel of each plug-in unit is called a word. Up to eight words of readout information can be displayed on the crt (two channels from each of the four plug-in compartments). The location of each readout word is fixed and is directly related to the plug-in unit and channel from which it originated. Figure 2-4 shows the area of the graticule where the readout from each plug-in unit and/or channel is displayed. Notice that the readout from channel 1 of each plug-in unit is displayed in the top division of the graticule and the readout from channel 2 is displayed directly below in the bottom division of the graticule. The REDUCED SCAN mode changes the location of the readout display. Figure 2-5 shows the correct readout location for the REDUCED SCAN mode. Notice that the readout display is positioned outside the half-size inner graticule and that the location of the readout words is directly related to the plug-in unit and channel from which they originated. Usually, the readout information for plug-in units and/or channels, which are selected by the mode switches, appear in the readout display. (Some special purpose plug-in units may over-ride the mode switches to display readout even though the compartment is not selected for display.)

READOUT IDENTIFY. An "Identify" feature is provided by the Readout System to correlate the readout word with the originating plug-in unit and channel (amplifier units only). When the "identify" button of an amplifier unit is pressed, the word IDENTIFY appears in the readout location allocated to that plug-in and channel. Other readout words

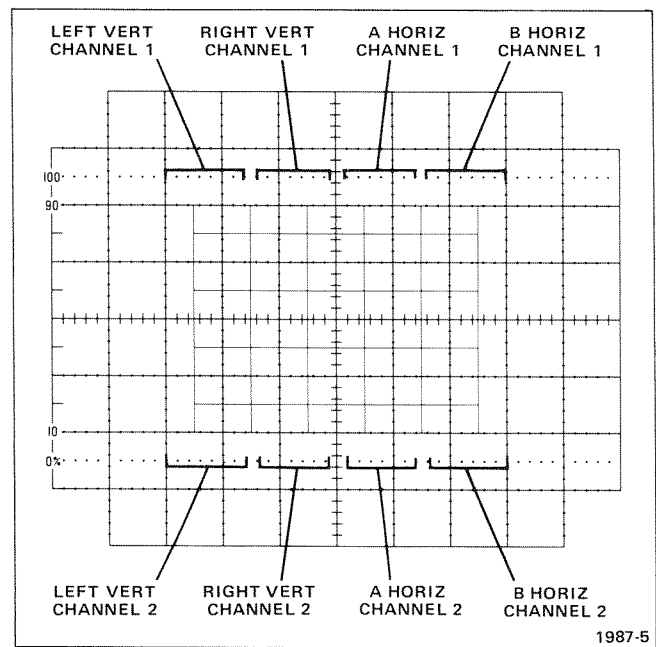

Figure 2-5. Location of readout on the crt when REDUCED SCAN is selected.

in the display remain unchanged. When the "identify" button is released, the readout display from this plug-in channel is again displayed. Circuitry may also be provided in the amplifier unit to produce a noticeable change in the analog waveform display to identify the associated trace when the "identify" button is pressed (see the plug-in unit instruction manual for details).

READOUT INTENSITY. The READOUT control determines the intensity of only the readout portion of the display, independently of the other traces. The Readout System is inoperative when the READOUT control is in the fully counterclockwise OFF position. This may be desirable when the top and bottom divisions of the graticule are to be used for waveform display, or when the trace interruptions necessary to display characters interfere with the waveform display.

READOUT MODES. The READOUT GATED or FREE RUN switch determines the operating mode of the Readout System. With the READOUT GATED or FREE RUN switch set to FREE RUN, the Readout System operates continuously, interrupting the usual crt display at random (for about 20 microseconds) in order to write each character on the crt. With the READOUT GATED or FREE RUN switch set to the GATED position, the Readout System operates in a triggered mode; one complete frame (up to eight words) of readout is displayed after the displayed time-base unit completes each sweep of the crt.

Operating Instructions—7834

Readout Operation With Storage. Each of the storage modes modify the operation of the Readout System, to some extent. With the READOUT GATED or FREE RUN switch set to FREE RUN the Readout System operates as follows:

BISTABLE AND VAR PERSIST. In the BISTABLE and VAR PERSIST positions, of the Storage Mode switch, the readout display is turned off during the storage erase cycle; otherwise, the Readout System operates as previously described under READOUT MODES.

FAST BISTABLE AND FAST VAR PERSIST. In the FAST BISTABLE and FAST VAR PERSIST positions, of the storage mode switch, the Readout System turns off at the beginning of an erase cycle or when the single-sweep time-base mode is reset and remains off until the end of the storage transfer cycle. In addition, the Readout System is held off whenever the MULTI TRACE DLY control is in operation (out of its detent position) and the displayed time-base unit is in a repetitive sweep mode.

With the READOUT GATED or FREE RUN switch set to GATED the Readout System operates as follows:

BISTABLE. In the BISTABLE storage mode, the readout display runs continuously (as in the free run mode); however, the readout system turns off when the storage erase cycle begins and remains off until the end of the first displayed sweep.

VAR PERSIST. In the VAR PERSIST storage mode one complete frame of readout is displayed after the displayed time-base unit completes each sweep; however, there is no readout display during a storage erase cycle.

FAST BISTABLE. In the FAST BISTABLE storage mode the readout display runs continuously (as in the Free Run mode); however, the readout system turns off at the beginning of each erase cycle or when the single sweep time-base mode is reset and remains off until the end of the storage transfer cycle. In addition, the readout system is held off whenever the MULTI TRACE DLY control is in operation (out of its detent position) and the displayed time-base unit is in a repetitive sweep mode.

FAST VAR PERSIST. In the FAST VAR PERSIST storage mode, one complete frame of readout is displayed after the completion of the storage transfer cycle. However, there is no readout during a storage erase cycle and there is no readout when the MULTI TRACE DLY control is out of detent position and the displayed time-base unit is in a repetitive sweep mode.

STORAGE SAVE READOUT MODES. When the storage system enters the SAVE mode, the operation of the readout system changes from that previously described under FREE RUN and GATED READOUT modes for the BISTABLE, VAR PERSIST, FAST BISTABLE, and FAST VAR PERSIST positions of the Storage mode switch. (Refer to the SAVE mode discussion, in this manual, for information on the SAVE mode operation.)

Save With Free Run Readout. With the READOUT GATED or FREE RUN switch set to FREE RUN and the Storage mode switch set to any one of the storage modes, the readout system turns off approximately 1 second after the storage system enters the SAVE mode.

Save With Gated Readout. With the READOUT GATED or FREE RUN switch set to GATED and the Storage mode switch set to BISTABLE or FAST BISTABLE, the readout is displayed for approximately 1 second after the storage system enters the SAVE mode, then it turns off; with the READOUT mode switch set to GATED and the Storage mode switch set to VAR PERSIST, 1 complete frame of readout is displayed at the end of the displayed sweep; with the READOUT mode switch set to GATED and the Storage mode switch set to FAST VAR PERSIST, 1 frame of readout is displayed at the end of the storage transfer cycle, or whenever the storage system enters the save mode and the MULTI TRACE DLY control is out of its detent position.

Reduced Scan Mode

The Reduced Scan mode increases the stored writing speed (in centimeters/microsecond). The calibrated graticule division size changes from 0.9 centimeters in the Full Scan mode to 0.45 centimeters in the Reduced Scan mode. Calibrated measurements are confined to the inner half-size 8 x 10 graticule area. The operation of the instrument controls do not change from their operation in the Full Scan mode.

Storage Display

The 7834 Storage Oscilloscope has four selectable storage modes. Listed in order of increasing writing speed, they are: BISTABLE, VARIABLE PERSISTENCE, FAST BISTABLE, and FAST VARIABLE PERSISTENCE. In each mode the viewed image is stored on the storage target located in the front of the crt.

In the BISTABLE mode the luminance of any point on the storage target will take on one of two discrete levels, either written or unwritten. In this mode, only the A or B INTENSITY controls affect the stored writing speed; writing speed is quite low but the stored view time is indefinitely long.

In the VAR PERSIST mode, points on the storage target can vary in luminance between totally dark and very bright. In this mode, writing speed is greater than in the BISTABLE mode, but the stored display is essentially unstable, or continuously fading away. The rate of fading is adjusted by the PERSISTENCE control. The VAR PERSIST storage mode is particularly useful for viewing high-speed repetitive signals with low repetition rates. The PERSISTENCE control can be adjusted in conjunction with the STORAGE LEVEL and INTENSITY controls, to produce a steady, bright trace. Writing speed is varied in this mode by the STORAGE LEVEL control as well as the crt INTENSITY controls. Maximum stored writing speed is achieved by setting the INTENSITY controls and the STORAGE LEVEL control fully clockwise.

The 7834 crt has a special high-speed target, known as the fast target, located just behind the storage target. The fast target has an extremely high writing speed but retains images for only a fraction of a second. For this reason images stored on the fast target are quickly and automatically transferred to the storage target; this operation is called transfer storage. Transfer storage can be used with the storage target operating in either bistable or variable persistence mode, resulting in the FAST BISTABLE and FAST VAR PERSIST modes.

In either of the FAST modes the writing speed is adjusted by the STORAGE LEVEL control, as well as the crt INTENSITY controls. Maximum stored writing speed in both FAST storage modes is attained by setting the STORAGE LEVEL and INTENSITY controls fully clockwise.

In all storage modes, an erase cycle removes any previous display from the storage target. This prepares the storage and fast targets (in the FAST storage modes) to receive the next waveform. Erase cycles are initiated by pressing the ERASE push button, grounding the rear panel REMOTE ERASE INPUT, or by rotating the AUTO ERASE control out of the OFF (detent) position. The AUTO ERASE control can be set to erase the storage display in 1- to 10-second intervals.

WARNING

Electric-shock hazard. Only qualified service personnel should internally modify the operation of the instrument.

Two modes of operation for the AUTO ERASE function are available, either Erase After Sweep or Periodic Erase (refer selection of either mode to qualified service personnel

only). The two modes differ in the following ways: The Erase After Sweep mode requires that the displayed time-base unit complete a sweep in order to initiate the delay interval prior to the erasure; the Periodic Erase mode repetitively erases independent of the displayed time-base operation.

Both time-base units and the readout system are inhibited during the erase cycle. Also during each erase cycle, the displayed time-base unit is reset if it is in single-sweep mode. (The other time base will also be reset at this time if it is also in single-sweep mode.) In the BISTABLE and VAR PERSIST storage modes, the erase cycle takes approximately 0.9 second; in the FAST BISTABLE and FAST VAR PERSIST modes, the erase cycle takes approximately 1.4 seconds. The additional time is required for preparing the fast target.

In all storage modes the time-base unit(s) is free to run immediately following an erase cycle. However, in FAST BISTABLE or FAST VARIABLE PERSISTENCE storage modes, the time-base unit(s) is locked out immediately after the first sweep occurs, so that transfer can occur. (In the ALT or CHOP horizontal modes, both time-base units are allowed to run once before transfer occurs.) If the time-base unit(s) is set for single-sweep operation, it remains locked out indefinitely after transfer occurs. The operator can initiate a cycle, however, called the multi-trace cycle, which causes another trace to be stored without erasing the initial display. This is accomplished by pressing the single-sweep-reset button on the time-base unit(s), or by grounding the REMOTE RESET INPUT on the 7834 rear panel. When this is done the storage system initiates a cycle, lasting approximately 600 milliseconds, which prepares the fast target to store another display and sends an additional single-sweep-reset command to the time-base unit(s). After the multi-trace cycle, the time-base unit(s) can again sweep once, after which it is again locked out and the transfer function occurs.

When the time-base unit(s) is operated in other than a single-sweep mode, the multi-trace cycle is controlled by the MULTI TRACE DLY control. If the MULTI TRACE DLY control is set to its detent position, operation is as previously described for the single-sweep mode. If the MULTI TRACE DLY control is out of the detent position, the multi-trace cycle is triggered automatically following the transfer cycle. The length of the cycle can be varied by the MULTI TRACE DLY control over a range from approximately 600 milliseconds to more than 4 seconds.

SAVE MODE. The SAVE mode can be entered from any storage mode by pressing the SAVE button or by grounding the rear-panel REMOTE SAVE INPUT. The indicator next to the SAVE push button switch illuminates when the

Operating Instructions—7834

SAVE mode is activated. When in the SAVE mode, the time-base unit(s) and readout system are inhibited and the display cannot be erased. The SAVE INTENSITY control adjusts the intensity of the saved display. Minimum intensity provides the greatest viewing time in the VAR PERSIST and FAST VAR PERSIST modes; and although the view time of the BISTABLE and FAST BISTABLE storage modes is very long without the use of the SAVE mode, the SAVE mode simplifies photography by allowing the operator to control the stored display's intensity.

The SAVE mode can be selected with or without a stored display present. If it is selected after an erase cycle and before a sweep has occurred (no stored display), then the display waits in the STORE mode until a sweep occurs, at which time the display automatically enters the SAVE mode. (This is referred to as the Auto Save mode.)

Care of Storage Screen

The following precautions will prolong the useful storage life of the crt used in this instrument:

1. Use minimum beam intensity to produce a clear, well-defined display.
2. Use minimum SAVE INTENSITY when storing images for extended periods of time.
3. Avoid repeated use of the same area of the screen. If a particular display is to be stored repeatedly, change the vertical position occasionally to use other portions of the display area.

Vertical and Horizontal Mode Combinations

There are 20 possible combinations of VERTICAL MODE and HORIZONTAL MODE switch settings. The total possible number of display combinations is further multiplied by the variety of plug-in units available for use with this instrument, the interchangeability of plug-ins (i.e., either an amplifier or a time-base unit can be installed in any compartment), and by the capabilities of the plug-in units which are used in the instrument (e.g., a dual-trace amplifier unit can be used in either of the two single-channel modes, in the dual-trace mode or added-algebraically mode; a delaying time base may be used either for a sweep or for delayed sweep). Therefore, it is difficult to list all of the display combinations which can occur during use of the 7834 and available plug-in units. Table 2-1 lists the combination of VERTICAL MODE and HORIZONTAL MODE switch positions available and the type of display obtained with each combination.

TABLE 2-1
Display Combinations¹

Vertical Mode	Horizontal Mode	Comments
LEFT	A or B	One trace. Vertical deflection from single unit; horizontal deflection from single unit.
	ALT or CHOP	Two traces. Vertical deflection from single unit; horizontal deflection from both units.
ALT	A or B	Two traces. Vertical deflection from both units; horizontal deflection from single unit.
	ALT or CHOP	Two traces. Vertical deflection from both units; horizontal deflection from both units. Independent-pairs (sweep slaving) operation, see Alternate Mode discussion in this section.
ADD	A or B	One trace. Vertical deflection shows algebraic summation of signals from both units; horizontal deflection from single unit.
	ALT or CHOP	Two traces. Vertical deflection shows algebraic summation of signals from both units; horizontal deflection from both horizontal compartments.
CHOP	A or B	Two traces. Vertical deflection shows signals from both units; horizontal deflection from single unit.
	ALT or CHOP	Four traces. Vertical deflection shows signals from both units; horizontal deflection from both units.
RIGHT	A or B	One trace. Vertical deflection shows signal from single unit; horizontal deflection from single unit.
	ALT or CHOP	Two traces. Vertical deflection shows signal from single unit; horizontal deflection from both units.

¹ Combinations given for single-channel vertical and horizontal units only.

VERTICAL MODES. When the LEFT or RIGHT button of the VERTICAL MODE switch is pressed, only the signal from the plug-in unit in the selected compartment is displayed.

Alternate Mode. The ALT position of the VERTICAL MODE switch produces a display which alternates between the LEFT VERT and RIGHT VERT compartments with each sweep of the crt. Although the ALT mode can be used at all sweep rates, the CHOP mode provides a more satisfactory display at sweep rates below about 20 milliseconds/division. At these slower sweep rates, alternate-mode switching becomes perceptible.

Alternate Mode displays have three types of triggering available. When the A and B TRIGGER SOURCE switches are set to the VERT MODE positions, each sweep is triggered by the signal being displayed on the crt. This provides a stable display of two unrelated signals, but does not indicate the time relationship between the signals. In either the LEFT VERT or the RIGHT VERT positions of the TRIGGER SOURCE switches, the two signals are displayed showing true time relationship. However, if the signals are not time related, the display from the plug-in that is not providing a trigger signal will be unstable on the crt.

When the ALT vertical mode is selected and either the ALT or CHOP button of the HORIZONTAL MODE switch is selected, the instrument operates in the independent-pairs mode. Under this condition, the signal from the LEFT VERT unit is always displayed at the sweep rate of the B HORIZ time-base unit, and the signal from the RIGHT VERT unit is displayed at the sweep rate of the A HORIZ time-base unit (non-delayed sweep only). This results in two displays that are completely independent as to vertical deflection and sweep rate. This display is equivalent to the display obtainable with a dual-beam oscilloscope for most repetitive-display combinations.

If delayed-sweep operation is used with this Mode, a different sequence is displayed. First, the LEFT VERT unit signal is displayed at the sweep rate of the A HORIZ time-base unit (delaying sweep) and then at the sweep rate of the B HORIZ time-base unit (delayed sweep). The vertical display then shifts to the RIGHT VERT unit and its signal is displayed consecutively at the delaying and delayed sweep rates.

Chopped Mode. The CHOP position of the VERTICAL MODE switch produces a display which is electronically switched between channels at about a one-megahertz rate. In general, the CHOP mode provides the best display at sweep rates slower than about 20 milliseconds/division or

whenever dual-trace, single-shot phenomena are to be displayed. At faster sweep rates the chopped switching becomes apparent and may interfere with the display.

When the A or B TRIGGER SOURCE switches are set to VERT MODE, internal trigger signals from the vertical plug-ins are algebraically added and the time-base units are triggered from the resultant signal. The LEFT VERT or RIGHT VERT trigger-source positions provide trigger signals to the time-base units on the internal trigger signal from the selected vertical unit only. This allows two time-related signals to be displayed showing true time relationship. (If the signals are not time-related, the display from the channel that is not providing the trigger signal will appear unstable.)

The CHOP mode can be used to compare two single-shot, transient, or random signals that occur within the time interval determined by the time-base unit (ten times selected sweep rate). To provide correct triggering, the displayed signal which provides the trigger signal must precede the second display in time. Since the signals show true time relationship, time-difference measurements can be made from the display.

Algebraic Addition. The ADD position of the VERTICAL MODE switch can be used (1) to display the sum or difference of two signals, (2) for common-mode rejection to remove an undesired signal, or (3) for dc offset (applying a dc voltage to one channel to offset the dc component of a signal on the other channel). The common-mode rejection ratio between the vertical plug-in compartments is at least 100:1 from dc to 150 megahertz. The rejection ratio decreases to 30:1 from 150 to 400 megahertz.

The overall deflection on the crt in the ADD mode is the algebraic sum of the signals from the two vertical plug-in units. It is difficult to determine the voltage amplitude of the resultant display unless the amplitude of the signal applied to one of the plug-ins is known. This is particularly true when the vertical units are set to different deflection factors, since it is not obvious which portion of the display results from the signal applied to a given plug-in unit. The polarity and repetition rate of the applied signals will also affect the ADD display.

The following precautions should be observed when using the ADD mode:

1. Do not exceed the input-voltage ratings of the plug-in units.

Operating Instructions—7834

2. Do not apply large signals to the plug-in inputs. A good rule is to not apply a signal of more than about eight times the vertical deflection factor. For example, with a vertical deflection factor of 0.5 volt/division, the voltage applied to that plug-in should not exceed four volts. Larger voltages may result in a distorted display.

3. To ensure the greatest dynamic range in the ADD mode, set the position controls of the plug-in units to a setting which would result in a mid-screen display if viewed in the LEFT or RIGHT positions of the VERTICAL MODE switch.

4. For similar response from each channel, use identical plug-ins and set the plug-in units for the same type of input or coupling mode.

HORIZONTAL MODES. When either the A or B button of the HORIZONTAL MODE switch is pressed, the signal is displayed at the sweep rate of the selected time-base unit. Set the applicable intensity control and trigger-source switch for the desired display.

Alternate Mode. The ALT position of the HORIZONTAL MODE switch provides crt sweeps derived alternately from the two time-base units. Although the ALT horizontal mode can be used at all sweep rates, the CHOP mode provides a more satisfactory display at sweep rates below about 20 milliseconds/division. At slower sweep rates, the switching between the alternate-mode traces becomes apparent and may interfere with correct analysis of the display.

NOTE

This instrument will not operate in the ALT position of the HORIZONTAL MODE switch if either horizontal plug-in compartment is left vacant.

The A and B INTENSITY controls allow individual adjustment of the traces produced by the time-base units in the A HORIZ and B HORIZ compartments. Correct triggering of both time-base units is essential in obtaining the correct display in the ALT horizontal mode. If either of the time-base units does not receive a correct trigger, and therefore does not produce a sweep, the other unit cannot produce a sweep either. This means that one time-base unit cannot begin its sweep until the previous unit has completed its entire display. This can be avoided if the time-base units are set for auto-mode triggering (sweep free runs if not correctly triggered). See Trigger Source for operation of the A and B TRIGGER SOURCE switches. Also, see

Vertical Trace Separation for information on positioning the B HORIZ display when in the ALT dual-sweep mode.

Chopped Mode. When the CHOP button of the HORIZONTAL MODE switch is pressed, the display is electronically switched between the two time-base units at about a 200 kilohertz rate. In general, the CHOP horizontal mode provides the best display when either of the time-base units is set to a sweep rate slower than about 20 milliseconds/division. It also provides the best display when the two time-base units are set to widely differing sweep rates. In the CHOP horizontal mode, equal time segments are displayed from each of the time-base units. This provides a display which does not change greatly, in intensity, as the sweep rate of either time-base unit is reduced (in contrast to ALT horizontal mode operation where the slowest trace tends to be the brightest).

The A and B INTENSITY controls allow individual adjustment of the intensity of the traces produced by the time-base units in the A HORIZ and B HORIZ compartments. Triggering is not as critical in the CHOP horizontal mode as in ALT; if one of the units is not triggered properly, only the trace from the untriggered time-base unit is missing from the display. The other trace is presented in the normal manner. See Trigger Source and Vertical Trace Separation for information on positioning the trace produced by the B HORIZ unit in relation to the trace from the A HORIZ unit.

Horizontal Selection. The Horizontal Selector switch provides the means to override the HORIZONTAL MODE switch in selecting the horizontal compartment for deflection. The Horizontal Selector switch has three positions (Normal, A, and B). In Normal the operation of the HORIZONTAL MODE switch is unchanged. In A or B the plug-in compartment selected by the Horizontal Selector switch provides the signal for horizontal deflection. The plug-in compartment selected by the HORIZONTAL MODE switch provides the other control signals, such as unblanking, storage control, etc.

The Horizontal Selector switch provides a convenient method of storing X-Y displays using the FAST BISTABLE or FAST VAR PERSIST storage modes. These storage modes require control signals, provided by a time-base unit or an external input signal (see REMOTE STORAGE GATE INPUT), to develop a stored display. For X-Y storage, the Horizontal Selector switch can be set to display the signal from an amplifier unit installed in one of the horizontal compartments. The HORIZONTAL MODE switch can select the other plug-in compartment, with a time-base unit installed, allowing the storage circuitry and crt unblanking to be controlled by the time-base unit while the horizontal deflection is provided by the amplifier unit.

Vertical Trace Separation

When one of the dual-sweep horizontal modes is selected, the VERT TRACE SEPARATION (B) control allows the trace produced by the B HORIZ sweep to be positioned above or below the trace produced by the A HORIZ sweep. To use the control, first position the trace produced by the A HORIZ plug-in unit. Then adjust the VERT TRACE SEPARATION (B) control to move the trace produced by the B HORIZ plug-in unit away from the A HORIZ display. If both waveforms are larger than four divisions in amplitude, the displays can only be positioned so they do not directly overlap since each waveform cannot be positioned to a unique area of the crt.

Trigger Source

The A and B TRIGGER SOURCE switches select the internal trigger signals for the A HORIZ and B HORIZ time-base units. For most applications, these switches can be left in the VERT MODE position. This position is the most convenient since the internal trigger signal is automatically switched as the VERTICAL MODE switch is changed or as the display is electronically switched between the LEFT VERT and RIGHT VERT plug-ins, in the ALT position of the VERTICAL MODE switch. It also provides a usable trigger signal in the ADD or CHOP positions of the VERTICAL MODE switch, since the internal trigger signal in these modes is the algebraic sum of the signals applied to the vertical plug-in units. Therefore, the VERT MODE position ensures that the time-base units receive a trigger signal regardless of the VERTICAL MODE switch setting without the need to change the trigger source selection.

If correct triggering for the desired display is not obtained in the VERT MODE position, the trigger source for either the A HORIZ or B HORIZ time-base unit can be changed to obtain the trigger signal from either the LEFT VERT or RIGHT VERT plug-in. The internal trigger signal is obtained from the selected vertical compartment whether the plug-in in that compartment is selected for display on the crt or not. If the internal trigger signal is obtained from one of the vertical units but the other vertical unit is selected for display, the internal trigger signal must be time-related to the displayed signal in order to obtain a triggered (stable) display.

Calibrator Output

The CALIBRATOR provides a convenient signal for checking basic vertical gain and sweep timing. The calibrator signal is also very useful for adjusting probe compensation as described in probe instruction manuals. In addition, the calibrator can be used as a convenient signal source for application to external equipment.

VOLTAGE. The CALIBRATOR provides accurate output voltages of 40 millivolts, 0.4 volt, and 4 volts into high

impedance loads. In addition, it provides 4 millivolts, 40 millivolts, and 0.4 volt into 50-ohm loads.

CURRENT. The optional current loop accessory provides a 40-milliampere output current (the CALIBRATOR must be set for 4 volt output), which can be used to check and calibrate current-measuring probe systems. The current signal is obtained by clipping the probe around the current loop.

REPETITION RATE. The repetition rate of the CALIBRATOR is 1 kilohertz. The calibrator circuit uses frequency-stable components to maintain accurate frequency and a constant duty factor. Thus, the CALIBRATOR can be used for checking the basic sweep timing of time-base units (1-kilohertz rate only).

WAVE SHAPE. The square-wave output signal of the CALIBRATOR can be used as a reference wave shape when checking or adjusting the compensation of passive, high-resistance probes. The square-wave output from the CALIBRATOR has a flat top; any distortion in the displayed waveform is due to the probe compensation.

Signal Outputs

+ **SAWTOOTH OUT.** The + SAWTOOTH OUT connector provides a positive-going sawtooth signal derived from the time-base unit installed in the A HORIZ compartment or from the time-base unit installed in the B HORIZ compartment.

WARNING

Electric-shock hazard present. Only qualified service personnel should internally modify the operation of the instrument.

It is possible to select either the A HORIZ or the B HORIZ compartment as the source of the + SAWTOOTH output signal. Refer such selection to qualified service personnel only. The unit of time for the sawtooth output is determined by the setting of the time-base-unit Time/Division switch. Refer to Table 1-4, in the General Information section, for signal parameters.

+ **GATE OUT.**

WARNING

Electric shock hazard present. Only qualified service personnel should internally modify the operation of the instrument.

Operating Instructions—7834

The + GATE OUT connector provides a positive-going rectangular pulse which is derived from a time-base unit installed in either horizontal plug-in compartment. The + GATE OUT signal can be selected from the time-base unit installed in the A HORIZ compartment or B HORIZ compartment. Refer such selection to qualified service personnel only. The duration of the + GATE OUT signal is the same as the duration of the respective sweep or, in the case of the delayed gate, it starts at the end of the delay period and lasts until the end of the sweep from the delaying time-base unit. Amplitude of the output signal at the + GATE OUT connector is about 0.5 volt into 50 ohms or about 10 volts into 1 megohm.

VERTICAL SIGNAL. The VERT SIG OUT connector provides a sample of the vertical deflection signal. The source of the output signal at this connector is determined by the A TRIGGER SOURCE switch. In the VERT MODE position of the A TRIGGER SOURCE switch, the output signal is determined by the setting of the VERTICAL MODE switch. The output signal in the LEFT and RIGHT positions of the VERTICAL MODE switch is obtained only from the selected vertical unit. In the ALT position of the VERTICAL MODE switch, the output signal at the VERT SIG OUT connector switches between signals from the two vertical units, along with the crt display. However, the vertical output signal in the CHOP position is a composite signal and is the same as that obtained in the ADD position due to the requirements of the triggering system. The LEFT VERT and RIGHT VERT positions of the A TRIGGER SOURCE switch are independent of the selection of the VERTICAL MODE switch and provide the vertical output signal only from the selected vertical unit even when it is not selected for display.

The output voltage into a 50 ohm load is about 25 millivolts/division of crt display and about 0.5 volt/division of display into a 1 megohm load. The output signal frequencies are determined by the vertical plug-in unit used (see Systems Specification in the General Information section).

PROBE POWER. The two PROBE POWER connectors on the rear panel of this instrument provide operating power for active probe systems. It is not recommended that these connectors be used as a power source for applications other than the compatible probes or other accessories which are specifically designed for use with this system. (Option 1 deletes these PROBE POWER connectors from the instrument).

Display Photography

A permanent record of the crt display can be obtained with an oscilloscope camera system. The instruction manual for the Tektronix Oscilloscope Cameras includes complete instructions for obtaining waveform photographs.

The crt bezel provides integral mounting for Tektronix Oscilloscope Cameras. The three pins located on the left side of the crt bezel connect power to compatible camera systems. Control signals are also received from Tektronix automatic cameras to allow camera-controlled single-shot photography (see camera manual for further information).

If the readout portion of the display is to be included on waveform photographs, the following suggestions will aid in obtaining good photographs.

1. Focus the oscilloscope display and the camera on the readout portion of the crt display. The auto-focus feature in this instrument will maintain the traces at optimum focus.
2. Set the READOUT intensity control for the minimum setting that allows the characters to be written. This normally occurs at a slightly lower intensity level than is necessary for complete writing of the waveform display. Some experimentation may be necessary to establish the correct level. Too high a setting of the READOUT intensity control will result in a broad, poorly defined photograph of the readout display.
3. If single-shot photography is used, set the READOUT FREE RUN or GATED switch to the GATED position (see Readout Display for complete operating information). Then, the readout is displayed in a single-shot manner after the trace is complete (be sure the camera shutter remains open at least 0.5 second after the sweep is completed to photograph the entire readout). Also, set the GRAT ILLUM control counterclockwise while the trace is being photographed. Then, the graticule can be photographed later to produce a double-exposed picture showing the complete information.

Intensity Modulation

Intensity (Z-axis) modulation can be used to relate a third item of electrical phenomena to the vertical (Y-axis) and the horizontal (X-axis) coordinates without affecting the waveshape of the displayed signal. This is accomplished by changing the intensity of the displayed waveform to provide a "gray scale" display.

The voltage amplitude required for visible trace modulation depends on the setting of the A and B INTENSITY controls. A two-volt peak-to-peak signal will completely blank the display even at maximum intensity levels; lower amplitude signals can be used to change only the relative trace brightness. Negative-going signals increase the display intensity and positive-going signals decrease the display intensity.

Refer to Table 1-4 in the General Information section for specifications on Z-axis signal requirements.

Time markers applied to the Z-AXIS INPUT provide a direct time reference on the display. With uncalibrated horizontal sweep or X-Y mode operation, the time markers provide a means of reading time directly from the display. If the markers are not time-related to the displayed waveform, use a single-sweep display.

Remote Input Signals

The signal source requirements to operate the remote input functions on the rear panel can be either active (pulse generator, logic circuit, etc.) or passive (switch or relay). Refer to Table 1-4, in the General Information section for specific parameters on each input.

REMOTE RESET INPUT. An external single-sweep-reset signal can be applied to time-base units installed in the horizontal plug-in compartments through the rear-panel REMOTE RESET INPUT connector. This remote reset function is a duplication of the manually-operated single sweep reset function (push button) located on the front panel of the 7B-Series time-base units.

REMOTE ERASE INPUT. The storage screen can be erased by applying a signal to the REMOTE ERASE INPUT. However, if the SAVE mode is being used the stored display cannot be erased by either front-panel erase controls or the rear-panel REMOTE ERASE INPUT signal.

REMOTE SAVE INPUT. The SAVE storage mode can be entered into by applying a signal to the REMOTE SAVE INPUT connector. The SAVE mode prevents accidental erasure and/or additional storage of the stored display.

REMOTE STORAGE GATE INPUT. The FAST BI-STABLE and FAST VAR PERSIST storage modes can be externally controlled by applying a gate signal to the REMOTE STORAGE GATE INPUT. The positive-going transition of the gate enables the transfer storage mesh to retain the display. The negative-going transition transfers the display stored on the transfer storage mesh to the storage screen (the display is not visible until transferred to the storage screen). However, if the displayed sweep starts before the positive transition of the remote storage gate the transfer storage mesh is enabled at the start of the displayed sweep. Then, the display stored on the transfer storage mesh will not be transferred until the displayed sweep has ended and the negative transition of the remote storage gate occurs.

APPLICATIONS

The 7834 Oscilloscope and its associated plug-in units provide a flexible measurement system. The capabilities of the overall system depend mainly upon the plug-in units selected for use with this instrument. Specific applications for the individual plug-in units are described in the plug-in unit instruction manuals. The overall system can also be used for many applications which are not described in detail, either in this manual or in the manuals for the individual plug-in units. Contact your Tektronix Field Office or representative for assistance in making specific measurements with this instrument.

The following books describe oscilloscope measurement techniques which can be adapted for use with this instrument:

John D. Lenk, "Handbook of Oscilloscopes, Theory, and Application", Prentice-Hall Inc., Englewood Cliffs, New Jersey, 1968.

J. Czech, "Oscilloscope Measuring Techniques", Springer-Verlag, New York, 1965.

J. F. Golding, "Measuring Oscilloscopes", Transatlantic Arts, Inc., 1971.

Charles H. Roth, Jr., "Use of the Oscilloscope", programmed text, Prentice-Hall Inc., Englewood Cliffs, New Jersey, 1970.

Vertical Amplifier Plug-In Units

All 7A-Series plug-in units (except the 7A21N unit) can be used with the 7834. Bandwidth and sensitivity ranges should be taken into consideration when selecting amplifier plug-in units.

SINGLE-TRACE. Any single-channel amplifier will display a signal, with the sweep provided by any 7B-Series time-base plug-in. This combination leaves two unused compartments available for other special purpose units. Blank plug-in panels are available to cover any unfilled plug-in compartments.

DUAL-TRACE. A dual-channel amplifier in either vertical compartment can display two separate signals with the other vertical compartment free for other uses.

THREE-TRACE. A dual-channel amplifier can be used with any single-channel amplifier to display three separate signals. If two time-base plug-in units are used in the horizontal compartments, two signals can be displayed at one sweep rate while the other signal is displayed at the other sweep rate.

Operating Instructions—7834

FOUR-TRACE. Two dual-channel amplifiers can display four separate signals. If one time-base unit is used, all four signals will be displayed at the same sweep rate.

Time-Base Plug-In Units

The 7834 is compatible with time-base units of the 7B70, 7B80 and 7B90 Series. Sweep rates and triggering ranges should be taken into consideration when selecting time-base plug-in units.

To obtain a delayed-sweep display, a delaying time-base unit must be installed in the A HORIZ compartment and a delayed time-base unit installed in the B HORIZ compartment. A delayed-sweep display can also be obtained with one horizontal plug-in unit in either horizontal compartment if a dual time-base unit is used. This leaves the other horizontal compartment available for other plug-in units as suggested later in this section.

The 7B50-Series time-base units are not recommended for use with this instrument because they require a longer delay line than is used in the 7834. Therefore, the triggering event may not appear on the display.

Sampling Displays

Sampling-system plug-in units for the 7000-Series oscilloscopes provide displays of fast-changing signals that cannot be examined using any other method. For example, sampling systems available for the 7834 can resolve repetitive signals having less than 10 millivolts of peak amplitude and occurring in less than 1 nanosecond.

The technique used for sampling is very similar in principle to the use of stroboscopic light to study fast motion. Samples of successive waveforms are taken, amplified by a relatively low-bandwidth amplifier, and then displayed on the crt as a replica of the sampled waveforms.

Three sampling systems are available at this time for the 7834: (1) the 7S12, which provides time-domain-reflectometry displays for general-purpose measurements, (2) the 7S11/7T11 system and (3) the 7S14, a dual-channel vertical sampling system, including main and delayed sweep functions. See the Tektronix Products catalog to determine the characteristics of the individual units mentioned and of additional units made available after this manual is published.

SINGLE-TRACE SAMPLING. A single-trace sampling display requires either a double-width 7S12 (which includes a time-base), or the 7S11 sampling unit and the 7T11 sampling sweep unit. Direct interconnections between the

7S11 and the 7T11 require these units to be adjacent, with the 7S11 in the RIGHT VERT compartment and the 7T11 in the A HORIZ compartment. If either the 7S12 or the 7S14 is used, it must be located in the middle two compartments to make the proper connections with the 7834.

DUAL-TRACE SAMPLING. Two 7S11's can be used with a single sampling time-base unit for time-related displays of two signals. Direct interconnections from the LEFT VERT 7S11 pass through the RIGHT VERT 7S11 to reach the A HORIZ time-base unit.

The 7S14 is a dual-channel sampling unit with delaying sweep capability. It must be used in the middle two plug-in compartments.

Dual-trace sampling displays can also be made by a 7S12 in the middle two compartments and a 7S11 in the LEFT VERT compartment. In this application, the 7S12 supplies the time-base for both traces.

X-Y SAMPLING. One 7S11 inserted in the RIGHT VERT compartment and one in the adjacent A HORIZ compartment automatically share a 50 kilohertz free-running strobe condition specified for X-Y displays. The 7S14 has an X-Y operation incorporated as one of its normal mode functions.

Special Purpose Plug-In Units

The variety of special-purpose plug-in units available allows the 7834 Oscilloscope to be used for many specialized applications. The following is a brief discussion of some of the available special-purpose plug-in units.

DIGITAL COUNTERS AND MULTIMETER PLUG-IN UNITS. The digital-multimeter plug-in units measure current, voltage, temperature, and resistance; digital-frequency-counter plug-in units measure frequency, from dc to above 500 MHz. These units make use of the readout system to display the measured information on the crt and can function in any compartment, in combination with each other or with any other plug-in units available for use with the 7834 oscilloscope system.

The ability of digital readout plug-in units to operate with other plug-in units makes it possible to process and monitor signals at the same time the digital measurement is being made. For example, by locating a frequency counter in one of the vertical compartments and an amplifier unit in the other vertical compartment, the crt can display the trigger waveform, superimposed on the displayed signal, to indicate the actual triggering point. Or, if the counter is placed in a horizontal compartment, a low-amplitude signal

can be applied to a vertical amplifier and amplified before it is internally routed by the trigger source switches to the counter trigger circuit. This allows the unit to be used on signals too small to trigger other counters.

READOUT ACCESS PLUG-IN UNIT. The 7M13 READ-OUT plug-in unit provides front-panel keyboard operation for convenient access to the crt readout characters. This allows information, such as dates and identifying nomenclature, to be displayed on the crt with the normal crt display. This capability is particularly useful when making photographs.

TRANSISTOR CURVE-TRACER PLUG-IN UNITS. The 7000-Series transistor curve-tracer plug-in checks small-signal transistors and diodes by producing a display showing the basic characteristic curves for the device being tested. Stepped sweep signals from an internal power supply are applied to the device under test. The resulting output signals are, in turn, applied to the horizontal and vertical deflection systems of the oscilloscope to plot a family of characteristic curves. This plot can be used to check for damaged transistors and diodes, or to select for special or matched characteristics and to calculate gain, leakage, breakdown voltage, etc.

SPECTRUM ANALYZER PLUG-IN UNITS. The 7000-Series spectrum analyzer plug-in units display applied-signal amplitudes dispersed over portions of the rf spectrum. Absolute signal energy is plotted on the vertical axis against frequency on the horizontal axis. Applications include waveform and distortion analysis, EMC and random noise measurements, filter design, spectrum surveillance, etc.

X-Y Operation

In some applications, it is desirable to display one signal versus another (X-Y) rather than against time (internal sweep). The flexibility of the amplifier plug-in units available for use with the 7834 provide the means of applying external signals to the horizontal-deflection system.

Installation of a 7A-Series amplifier plug-in unit in one of the horizontal and one of the vertical compartments provides X-Y operation. For further information, refer to the horizontal specifications in this manual and to the individual instruction manuals for the amplifier units.

Some of the 7B-Series time-base units can be operated as amplifiers in addition to their normal uses as time-base generators. This feature allows an external signal to provide the horizontal deflection to the crt. For most of the time-base units with the amplifier function, the X (horizontal) deflection signal can be connected either to an external input connector on the time-base unit, or it can be routed to the time-base unit through the internal triggering system (see time-base instruction manual for details). If the latter method is used, the A and B TRIG SOURCE switches must be set so that the X (horizontal) deflection signal is obtained from one of the vertical amplifier units and Y (vertical) deflection signal is obtained from the other vertical unit. The attenuator switch on the amplifier unit can provide the horizontal with a preconditioned signal, compatible with the horizontal deflection factor. Also, plug-in units need not be moved from one compartment to another to change from X-Y operation to other modes of operation.

Raster Displays

A raster-type display can be used effectively to increase the apparent sweep length. For this type of display, the trace is deflected both vertically and horizontally by sawtooth signals. This is accomplished in the 7834 by installing a 7B-Series time-base unit in one of the vertical plug-in compartments. Normally, the time-base unit in the vertical compartment should be set at a slower sweep rate than the time-base unit in the horizontal compartment; the number of horizontal traces in the raster depends upon the ratio between the two sweep rates.

Information can be displayed on the raster using several different methods. In the ADD position of the VERTICAL MODE switch, the signal from an amplifier unit can be algebraically added to the vertical waveform. With this method, the vertical signal amplitude on the crt should not exceed the distance between the horizontal lines of the raster. Another method of displaying information on the raster is to use the Z-AXIS INPUT to provide intensity modulation for the display. This type of raster display could be used to provide a television-type display. Complete information on operation using the Z-axis feature is given under Intensity Modulation.

To provide a stable raster display, both time-base units must be correctly triggered. Internal triggering is not provided for the time-base units when they are in the vertical compartments; external triggering must be used. Also, blanking is not provided from the time-base units when they are installed in a vertical compartment.

INSTRUMENT OPTIONS

Your instrument may be equipped with one or more instrument options. A brief description of each available option is given in the following discussion. Option information is incorporated into the appropriate sections of the manual. Refer to Table 3-1 and the Table of Contents for location of option information. For further information on instrument options, see your Tektronix Catalog or contact your Tektronix Field Office.

WARNING

To avoid electric-shock hazard, operating personnel must not remove the protective instrument covers. Component replacement and internal adjustments must be made by qualified service personnel only.

OPTION 1

This option eliminates the Readout System and the PROBE POWER connectors. Operation of the instrument is unchanged except that there is no alpha-numeric display on the crt and the READOUT control is nonfunctional. The Readout System can be added at any time by ordering the Readout Conversion Kit. Refer to the Tektronix Products catalog for the part number.

OPTION 2

The X-Y Delay Compensation network equalizes the signal delay between either vertical compartment and the B HORIZ compartment. When this network is installed and activated, the phase shift between the vertical and B horizontal channels is adjustable to less than 2° from dc to 1 megahertz. This option can be added at any time. Refer to the Tektronix Products catalog for the part number.

OPTION 3

With Option 3 installed, the instrument will meet EMC (electromagnetic compatibility) specifications given in Section 1. This option can be added at any time. Refer to the Tektronix Products catalog for the part number.

TABLE 3-1
Option Information Locator

Instrument Option	Manual Section	Location of Information
Option 1 (Deletes Readout and probe power connectors)	<p>2 Operating Instructions</p> <p>3 Instrument Options</p>	<p>Readout Display; includes Option 1 description.</p> <p>Introductory page includes a brief description of Option 1.</p>
Option 2 (Provides X-Y Delay Compensation)	<p>1 General Information</p> <p>3 Instrument Options</p>	<p>Specification Table 1-4 contains the electrical characteristics for Option 2.</p> <p>Introductory page includes a brief description of Option 2.</p>
Option 3 (Provides EMC)	<p>1 General Information</p> <p>2 Operating Instruction</p> <p>3 Instrument Options</p>	<p>Specification Table 1-5 contains the electrical characteristics for Option 3.</p> <p>Detailed Operating Information Light Filter; includes basic description.</p> <p>Introductory page includes a brief description of Option 3.</p>

MANUAL CHANGE INFORMATION

At Tektronix, we continually strive to keep up with latest electronic developments by adding circuit and component improvements to our instruments as soon as they are developed and tested.

Sometimes, due to printing and shipping requirements, we can't get these changes immediately into printed manuals. Hence, your manual may contain new change information on following pages.

A single change may affect several sections. Since the change information sheets are carried in the manual until all changes are permanently entered, some duplication may occur. If no such change pages appear following this page, your manual is correct as printed.



